

Imagine the possibilities...





Nema Associates Inc.
408 E. Elizabeth Ave. Linden, NJ 07036
(908) 275-3840

DISPLAY FOLIO[®]

Exhibit & Display Catalog

In the demanding environments where display products are relied on day after day, customers increasingly recognize the importance of quality and of having a partner who can support their evolving needs.

Whether you need one stock item or five thousand custom frames, we are committed to being your source for quality and value in visual merchandising.

We continue to invest to improve the quality of the products and services we deliver to you, our customers. It takes a team effort from our employees, whose priority is ensuring that your projects are successful. Our approach has always been to listen carefully to our customers, and to deliver products that meet your evolving display needs. We service a wide range of industries.

We are proud of our extraordinary reputation for quality, value and reliability. We source the finest quality components, and because we manufacture in the U.S., our supply chain is shorter, "greener", and we can offer customizable solutions tailored to your needs. We are excited about our future and look forward to continuing our pursuit of opportunities together!

SignPost à la Carte™

Sign Post à la Carte Ordering

Design a custom solution using multiple frames, banner rods, graphic clips and literature holders. Also, many of our CREO accessories can be accommodated to this system. Our friendly sales staff is ready to help!



Uprights

Aluminum alloy, slotted 2 sides. Architectural cap.

YU6	72"
YU8	96"

-S Silver -B Black



Laser Cut Bases

Matte texture finish.

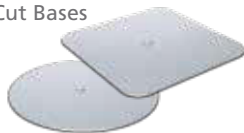

YBQ	16" Square	17 lbs.
YBR	17" Round	16 lbs.

-S Silver -B Black

Drop In Perfex Frames

Graphic sizes:

YPX5	22" x 28"
YPX6	24" x 36"
YPX9	22" x 56"

-S Silver -B Black



SnapFrames

Front load, includes matte lens & back.

YE07	22" x 28"
YE09	24" x 36"
YE56	22" x 56"

-S Silver -B Black



Special order with clear lens.

Graphic Rods

Sleek, moveable 5/8" diameter tubes. Aluminum face-out puck for hemmed graphics. 2/set.

CRGR-1	18"
CRGR-2	24"



Design the stand best suited to your client's display opportunity!



Panel Grippers
Frameless graphic attachment of rigid substrates.



Specify thickness:

- CRPG1** .020" - .125"
- CRPG2** .125" - .250"

CRPG interlocking, 2 pairs per.

Graphic Clips
Snaps on, holds semi-rigid and rigid graphics up to 1/8" thick. Strong economical option.



HT3 Set of 2

Literature Holders
Steel powder coated. Can use 2 back to back, center hung.



- YLTP1** - Pamphlet (4)
 - YLTC1** - Catalog (2)
- S Silver -B Black

Literature Holders
Steel powder coated. Can use a left and a right, side by side. 9" x 11-3/4".



- CRLSLM** left mount
 - CRLSRM** right mount
- S Silver -B Black

SignPost Frame Kits™

Frame/Stand Kits

These complete SignPost outfits include a laser cut weighted steel base with a durable matte finish, an aluminum 72" upright slotted on two sides for height adjustments, and a choice of two aluminum frame styles: drop-in or front snap-open.

Sold as complete sets, many of our À la Carte & Creo accessories can be added. Our sales staff is ready to help!



Y1SN2CHRD-S



Y1SN2CHRD-S
with YLTC1-S



Y2SN2CHSQ-S



Y2PD9CHRD-S



Y2PD2CHSQ-S
with (2) YLTP1-S



Y2SN2CHRD-S
with (4) YLTC1-S

Kit Ordering:

# of Frames	Frame Type	Graphic Size	Frame Position*	Base*	Color*	
Y1 One Frame	SN SnapFrame	2 22" x 28"	CH Center Hung	SQ Square	-S Satin Silver	*Does not affect price
Y2 Two Frames	PD Perfex Drop In	4 24" x 36"	OF Offset	RD Round	-B Matte Black	
		9 22" x 56"				

Beautifully Designed, Extraordinary Stability!



Y1PD4CHSQ-S



Y2PD4CHSQ-S
with (2) YLTP1-S



Y1PD4OF
with (3) CRLSRM-S



Y1PD9OFRD-S



Y2SN2OFRD-S
with (2) YLTC1-S

Drop In Perfix Frames
Viewable 2 sides,
3/16" full top entry slot.
Mounting hardware
included. Center or
offset hung.



SnapFrames
Front load, matte lens &
styrene back. For posters
and paper signs up to
1/32" thick. Special order
with clear lens. Center or
offset hung.



Literature Holders
Steel, can use 2 back
to back. Center hung.
YLTP1 - Pamphlet (4)
YLTC1 - Catalog (2)
-S Silver -B Black



Literature Holders
Steel powder coated. Can be used
side by side. 9" x 11-3/4".
CRLSLM left mount
CRLSRM right mount
-S Silver -B Black



Hybrid SnapFrames™

HYBRID SNAPFRAMES

Aluminum covers atop plastic SnapFrames - 1-1/4" wide, no springs.



HE7-S

Features:

- Aluminum Covers
- Plastic SnapFrame
- No metal springs
- Matte or clear lens
- Satin silver or matte black finish
- Precision mitered corners
- White plastic corrugated backer
- Wall anchors & mounting screws
- Accepts substrates to 1/32" thick

Specify: Model – Color* – Lens*

Model	Graphic Size	Model	Graphic Size
HE7	22" x 28"	HE10	30" x 40"
HE9	24" x 36"	HE11	36" x 48"

Color*

-S	Satin Silver
-B	Matte Black

Lens*

-C	Clear Lens
-M	Matte Lens

*Does not affect price.

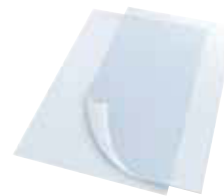

Choice!

Hybrid SnapFrames come with a choice of:
-C Clear or **-M** Matte lenses.

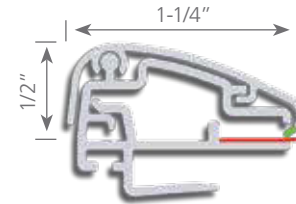

Beautifully mitered corners.

Holes for horizontal or vertical wall mounting.

Aluminum frame cover.

Plastic SnapFrame - no springs.

Satin silver or matte black finish.

Plastic corrugated backing.

Choice of matte or clear lens.

CHANGE
 GRAPHICS
 EFFORTLESSLY



3/8" margin.

FANTASTIC NEW DESIGN HOLDS GRAPHICS SECURELY

HYBRID SNAPFRAMES

Aluminum covers atop plastic SnapFrames - no springs.



Custom sizes available.



Double sided, back to back versions available - call our friendly sales staff.
Perfect for windows and mid store positions.

CHANGE GRAPHICS EFFORTLESSLY
FOR SEASONAL PROMOTIONS.

Plasti SnapFrames™

ATTRACTIVE STRONG & EXTREMELY COST EFFECTIVE



Front Loading Plasti SnapFrames

- PVC frame, 1-1/8" wide, 5/8" deep
- Plastic corrugated backer
- Accepts posters to 1/32" thick
- One piece "living hinge" construction
- Vertical & horizontal mounting holes
- Wall screws and anchors included

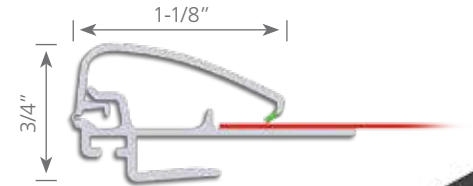

Specify: Model - Color* - Lens type if applicable*

Frame No	Lens	with/Lens*	Graphic Size
PE1	PE1L		8" x 10"
PE2	PE2L		8-1/2" x 11"
PE3	PE3L		11" x 14"
PE3.5	PE3.5L		11" x 17"
PE4	PE4L		14" x 22"
PE5	PE5L		16" x 20"
PE6	PE6L		20" x 24"
PE7	PE7L		22" x 28"
PE8	PE8L		24" x 30"
PE9	PE9L		24" x 36"
PE10	PE10L		30" x 40"
PE11	PE11L		36" x 48"

Color*

- S Satin Silver
- B Matte Black

Black is NOT recommended in direct sunlight.

For those models with lenses* indicate

- C Clear
- M Matte

*Does not affect price.



Beautifully mitered corners.

Holes for horizontal or vertical wall mounting.

Co-extruded SnapFrames - no springs

Strong PVC frame.

Plastic corrugated backing.



3/8" margin.

CHANGE GRAPHICS EFFORTLESSLY!

EASY-OPEN SNAPFRAME DIVIDERS



Bars are permanently positioned wherever the client wants.

Good for ME (mitered), EO (radiused corners) & Plasti SnapFrames.

Quotes provided on a project basis, contact our friendly sales staff with a sketch of what you'd like quoted.

Not available for SupraSlim™ models.
Color Choices:

- S Satin Silver
- B Matte Black

Graphic changes are effortless, and the satin aluminum finishes are aesthetically beautiful.

Satin anodized aluminum Divider Bars work with our Plasti & Easy-Open SnapFrames™ - both mitered & radius cornered models. Not available for SupraSlim™ models.



FRONT LOADING CONVENIENCE.

IT'S A SNAP!
SO EASY!

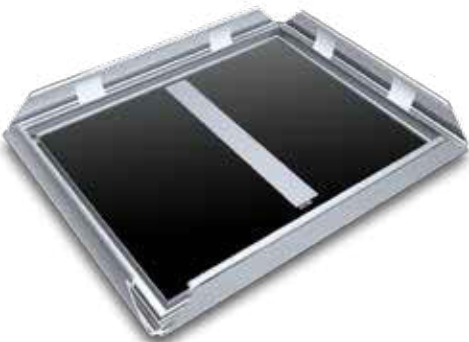

Divider Bars attach with pressure sensitive adhesive to the styrene backer.

SupraSlim SnapFrames™



Two units shown side by side.

FRONT LOADING CONVENIENCE

Features:

- Aluminum rails, 3/4" wide, 1/2" deep
- Accepts substrates up to 1/32" thick
- Matte or clear lens included
- Styrene backing included
- Mounts vertically or horizontally
- Wall hangers provided

Choice of matte or clear lens included.

Strong spring loaded.

Styrene backing.



Live area:
3/8" margin.



CHANGE GRAPHICS EFFORTLESSLY



Mitered Corners

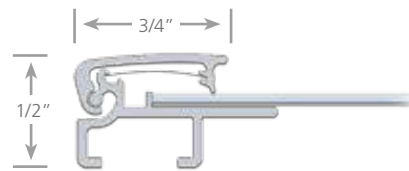

SupraSlim Profile



Matte Anodized Finishes

GREAT FOR ARCHITECTURAL APPLICATIONS



Super slim profile focuses attention on the message.

Choice!

SupraSlim SnapFrames come with a choice of:
-**C** Clear or -**M** Matte lenses.

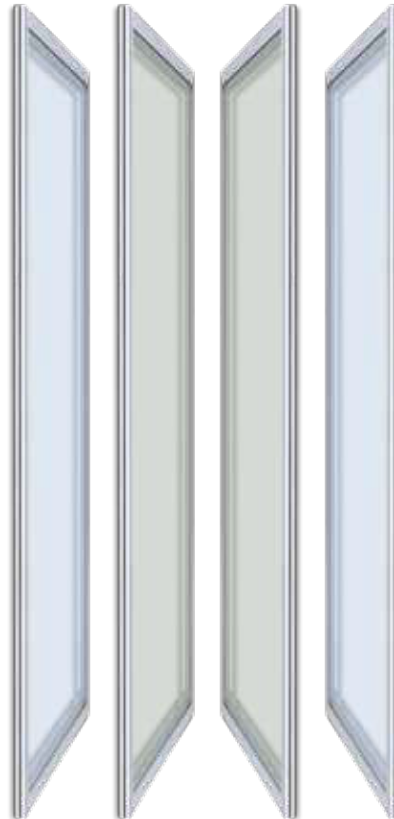

3/4" WIDE
1/2" DEEP

SHIPS FULLY
ASSEMBLED



Mount vertically or horizontally,
wall mount hardware included.

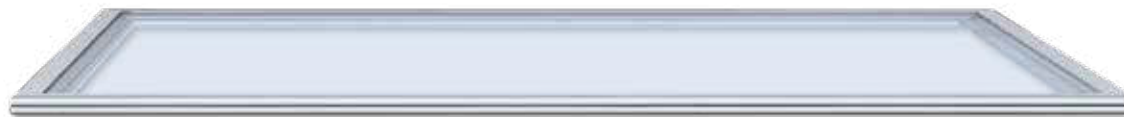

Specify: Model-Color-Lens*

Model	Size
SUP01	8" x 10"
SUP02	8-1/2" x 11"
SUP03	11" x 14"
SUP3.5	11" x 17"
SUP04	14" x 22"

Color
- S Satin Silver
- B Matte Black

Silver costs less than black.

Lens*
- C Clear
- M Matte

*Does not affect price.

Model	Size
SUP05	16" x 20"
SUP06	20" x 24"
SUP07	22" x 28"
SUP08	24" x 30"
SUP09	24" x 36"

EasyOpen SnapFrames™

CHANGE GRAPHICS EFFORTLESSLY

Features:

- Aluminum frames, 1-1/4" wide, 9/16" deep
- Accepts posters and paper signs to 1/32" thick
- Vertical & horizontal mounting holes
- Styrene backing
- Clear or matte overlay lens
- Wall screws and anchors

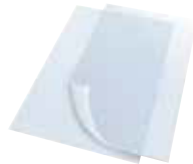
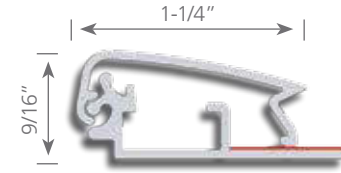

Choice!

ME & EO SnapFrames now come with a choice of:
-C Clear or **-M** Matte lenses.

- Styrene backing
- Clear or matte overlay lens
- Wall screws and anchors

Spring loaded sides for easy insertion.

Slots for horizontal or vertical wall mounting.

Beautiful mitered corners.

Lightweight aluminum frame available in satin silver, or matte black.

Clear or matte overlay lens included atop a styrene backing.

Specify: Model-Color-Lens*

Mitered	Graphic Size	Mitered	Graphic Size
ME1	8" x 10"	ME6	20" x 24"
ME2	8-1/2" x 11"	ME7	22" x 28"
ME3	11" x 14"	ME8	24" x 30"
ME3.5	11" x 17"	ME9	24" x 36"
ME4	14" x 22"	ME10	30" x 40"
ME5	16" x 20"	ME11	36" x 48"



3/8" margin.

Color: **-S** Satin Silver **-B** Matte Black

Silver costs less than black. Lens* **-M** Matte Lens **-C** Clear Lens *Does not affect price.

RADIUS CORNER SNAPFRAMES

AESTHETICALLY BEAUTIFUL

- Aluminum frames, 1-1/4" wide, 9/16" deep
- Accepts substrates up to 1/8" thick
- Semi-rigid plastic backing
- Clear or matte overlay lens included
- Vertical or horizontal mounting slots
- Four wall screws and anchors



Specify: Model-Color-Lens*

Mitered	Graphic Size	Mitered	Graphic Size
EO1	8" x 10"	EO6	20" x 24"
EO2	8-1/2" x 11"	EO7	22" x 28"
EO3	11" x 14"	EO8	24" x 30"
EO3.5	11" x 17"	EO9	24" x 36"
EO4	14" x 22"	EO10	30" x 40"
EO5	16" x 20"	EO11	36" x 48"

Color

-S Satin Silver -B Matte Black

Silver costs less than black.

Lens*

-C Clear -M Matte *Does not affect price.

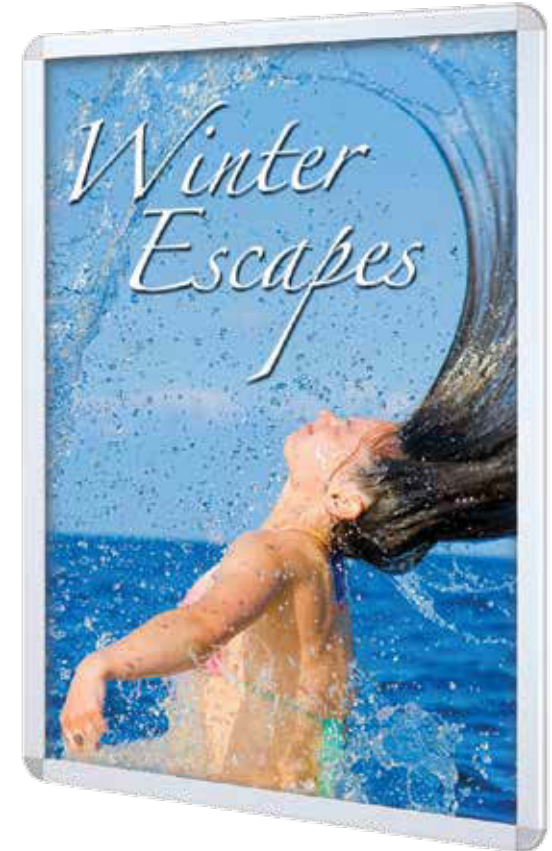

Beautiful molded radius corners.

Radius SnapFrames accept substrates up to 1/8" thick, whereas our mitered units accept substrates only up to 1/32" thick.

Also Available:

Double-Sided

Special order frames are available. Please indicate vertical or horizontal so we know where to put the hangers.

Bulk Components

SnapFrame extrusions are available in long lengths with components bulk packed.



3/8" margin covered on all sides.

EasyOpen SnapFrames™

EasyOpen SnapFrame Pedestal Stands

Stylish and elegant. Use for menus and other displays. Perfect for public lobbies, restaurants, retail & tradeshows.

- Easy-Open™ SnapFrames
- All metal construction
- Styrene backs
- Matte lens included
- Accepts graphics to 1/32" thick
- Sturdy, quick graphic/signage change-outs



Featuring heavy 14" x 12" steel bases, racetrack oval 37" aluminum uprights, horizontal orientation.

Featuring round laser cut bases and 36" high upright aluminum poles.

Aluminum front open SnapFrames, Laser cut round 3/16" steel bases.

Model	Size	Color*
ETD1	17" x 11"	-S Satin Silver
ETD2	22" x 14"	-B Matte Black

Special order clear lens.

*Doesn't affect price.

Model	Size	Pole	Base
ETO	8.5" x 11"	36" Straight	11" Round
ET3	11" x 14"	36" Straight	11" Round
ET1	11" x 17"	36" Straight	15" Round
ET2	14" x 22"	36" Straight	15" Round



Specify Orientation*:	
H	Horizontal
V	Vertical

Special order clear lens.



Color*:	
-S	Satin Silver
-B	Matte Black

*Doesn't affect price.

Angled EasyOpen SnapFrame Pedestal Stands

Perfect for public lobbies, restaurants, retail & tradeshows.

- Oval laser cut bases
- Aluminum SnapFrames
- 43" high curved uprights
- Matte overlay lens included

Poster Size EasyOpen SnapFrames

Strong, built to last.

- Aluminum 1-1/4" wide SnapFrames
- EasyOpen convenience. 66" total height
- Accepts graphics up to 1/32" thick
- Matte overlay lens, floor levelers



EF4EOH-B with PB1C lit. basket.

EF3EOV-S



Elegant aluminum racetrack oval uprights.

No bottom crossbar on double sided units.

LF5EO1-B

LF5EO2-S

Specify: Model —Orientation*—Color*

Specify: Model —Color*

Model	Size	Pole	Base
EF1EO	8.5" x 11"	43" Curved	Oval
EF3EO	11" x 14"	43" Curved	Oval
EF4EO	11" x 17"	43" Curved	Oval

Orientation*:	
H	Horizontal
V	Vertical

Special order clear lens.

Color*:	
-S	Satin Silver
-B	Matte Black

*Doesn't affect price.

Model	Size	Style
LF5EO1	22" x 28"	One-Sided
LF6EO1	24" x 36"	One-Sided

Special order clear lens/es.

Model	Size	Style
LF5EO2	22" x 28"	Double-Sided
LF6EO2	24" x 36"	Double-Sided

FrameGraphix SnapFrames™

CHANGE
GRAPHICS
EFFORTLESSLY



GREAT DISPLAY OPTIONS



Also available 2 sided.

Accepts graphics up to 50 mil.
Opaque styrene backing included.

ORDERING :

Specify: Model—Mounting*—Orientation*—Color*

Model	Size	Mounting*	Color*
XE1422	14" x 22"	CN Ceiling Hung	-S Satin Silver
XE1824	18" x 24"	WM Wall Mount	-B Matte Black
XE2228	22" x 28"		
XE2430	24" x 30"		
XE2436	24" x 36"		
XE3648	36" x 48"		

Orientation*

H Horizontal
V Vertical

* Does not affect price.
Custom sizes quoted on request.

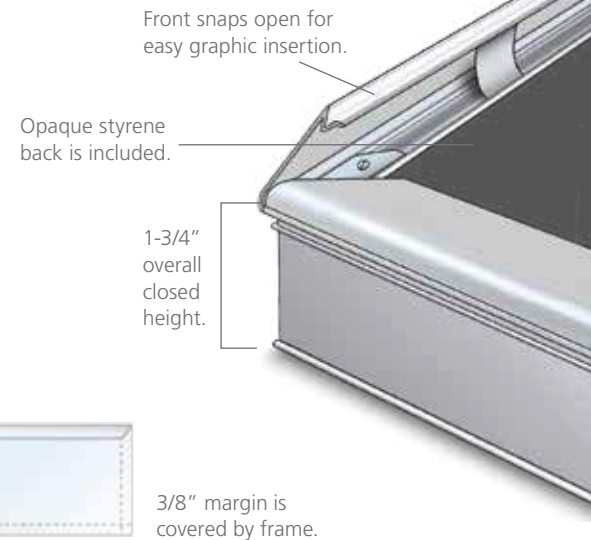

Beautifully mitered corners, aluminum alloy frame, satin silver or matte black finish.

Above frames are all 1 sided. 2 sided frames available.

Silhouette Aluminum Trim Frames

Silhouette Aluminum Trim Frames feature ultra low price points.

- Super lightweight
- Extremely economical
- Real aluminum alloy
- Satin silver or matte black
- Adhesive backed
- Mitered corners
- Can be cut to any size
- Great as frame trim
- 3/32" max. media thickness



Incredibly just 1/4" slim, incredibly economical.

Use for Wall Mount applications.



CUSTOM SIZES ARE OUR SPECIALTY!

Specify: Model — Color*

Model	Graphic Size	Model	Graphic Size
OU1	8-1/2" x 11"	OU4	14" x 22"
OU2	11" x 14"	OU5	22" x 28"
OU3	11" x 17"	OU6	24" x 36"

*Color: -S Satin Silver -B Matte Black * Does not affect price.



Removable adhesive backing.



Live area: 1/8" margin covered by the frame.



Graphic entry on short side.

Units ship completely assembled, individually bagged, bulk packed.

RETAIL



CORPORATE



HOME



HOSPITALITY



Perflex Hanging Frames™



SOLD AS A KIT
 includes:
 2 universal hanging clips
 and
 2 top & bottom wall hangers.

Other hanging hardware options available.



Curvilinear Satin Silver



Rectilinear Matte Black

Frames are 1" wide x 5/8" deep.

Specify: Model–Style*–Orientation*–Color*

Model	Graphic Size
PX1	8-1/2" x 11"
PX2	11" x 14"
PX3	11" x 17"
PX4	14" x 22"
PX5	22" x 28"
PX6	24" x 36"

Orientation*	
H	Horizontal
V	Vertical

Color*	
-S	Satin Silver
-B	Black Matte

Style*	
CV	Curvilinear
RE	Rectilinear

*Doesn't affect price, but must use to order.

Units come fully assembled, 1 per carton.

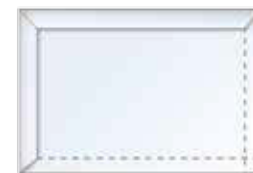
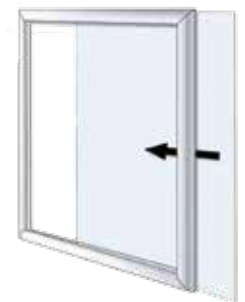

Image area:
 3/8" margin covered by frame.



On large rollouts, packing each into a polybag & bulk can save significantly. Price on request.

Side loading. 3/16" full open slot.
 Accepts 3/16" graphic and (2) CPL 1/32" lenses (see next pg.).

Perfex Hanging Frames™

Plastic lenses Sold in pairs.

Clear	Matte	Size
CPL3	CPM3	8-1/2" x 11"
CPL4	CPM4	11" x 14"
CPL5	CPM5	11" x 17"
CPL6	CPM6	14" x 22"
CPL7	CPM7	22" x 28"
CPL8	CPM8	24" x 36"



Coroplast® Backs

White, 4 mm corrugated plastic boards make excellent frame backs. Sold individually.

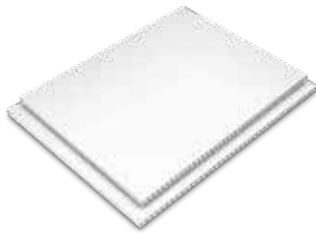

COR3	8-1/2" x 11"
COR4	11" x 14"
COR5	11" x 17"
COR6	14" x 22"
COR7	22" x 28"
COR8	24" x 36"



Dividers



Matching anodized dividers now available. Contact sales for details.



Hanging Clip included, not wire.

Aluminum frame, curvilinear (shown) or rectilinear.

Precision mitered corners.

Satin silver or matte black finish.

Accessories:

Hang frames in series using Universal Clips & Double C Hooks. (Hardware pg. 90).



UCSW
Slatwall Kit includes 2 steel braces.



UCWM
Wall Mount Kit, includes 2 top & 2 bottom hangers.

Perfex Pedestal SignFrames™

CURVILINEAR, ALL METAL

- Heavy duty extruded alloy
- Frames have top entry slot
- Accepts graphics to 3/16" thick
- All frames are open 2 sides

CONTEMPORARY DESIGN



Top loading, accepts media to 3/16" thick.



Image area:
3/8" margin is covered by the frame.
Frame is 1" wide x 5/8" deep.

Specify: Size, Base, Upright, Orientation*, Color*

Size

SF3S	8-1/2" x 11"
SF4S	11" x 14"
SF5S	11" x 17"
SF6S	14" x 22"

Base

SQ Square steel	12" sq. 5lb. SF3, 4, 5	16" sq. 9lb. SF6
RD Round discs	11" 5lb. SF3, 4, 5	13" 7lb. SF6

Upright

TP	Telescopic 26"-50"
X	Fixed 36"

Orientation*

H	Horizontal
V	Vertical

Color*

-S	Satin Silver
-B	Matte Black

*Doesn't affect price, but must use to order.

Handsome combination of Curvilinear design and precision mitering.



Curvilinear Satin Silver

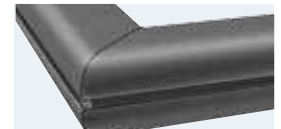

Curvilinear Matte Black



SF5SRDTPV-B



SF3SRDTPH-S



SF4SSQXH-B with
PB1C Pamphlet Holder

ECLIPSE CONCAVE PEDESTALS™

Elegantly stylish design.
Choose curved back or straight back.

Use standard paper sizes.

Features:

- Metal construction
- Non-glare overlay
- 9" x 14" oval bases
- Standard pole length is 43"
- Satin finishes
- Handsome support rails
- Felt bottoms

Specify: Size -Back* -Orientation* -Color*

Size

EF1	8-1/2" x 11"
EF3	11" x 14"
EF4	11" x 17"

Orientation*

H	Horizontal
V	Vertical

Graphic Back*

CV	Curved
F	Flat

Color*

-S	Satin Silver
-B	Matte Black

*Not on price sheet, must use to order.

Non - glare overlay provided.



EF3CVH-S
Shown with **PB2C**



EF4CVV-B



EF3CVV-S
Shown with **PB1C**



EF4FH-B

Pamphlet Catalog Holders

PB1C	4" w x 2" d
PB2C	9" w x 2" d



PB1C



PB2C

These fit on all stands this page.

Signs Anywhere™



Ceiling Anchor

Strong steel clip attaches easily to grid ceilings, 6" riser. Side entry.

PX1A	8-1/2" x 11"
PX2A	11" x 14"
PX3A	11" x 17"



Curvilinear Satin Silver



Magnetic Mount

3-1/4" Round magnetic base for gondola tops, posts & other steel surfaces. 6" riser. Side entry.

PX1M	8-1/2" x 11"
PX2M	11" x 14"
PX3M	11" x 17"



Curvilinear Matte Black



Flange

3-1/4" round steel flange screws to wall or ceiling. 6" riser. Side entry.

PX1F	8-1/2" x 11"
PX2F	11" x 14"
PX3F	11" x 17"

All frames this page accept graphics up to 3/16" thick.

Specify:

Model — Orientation* — Color*

Orientation*	Color*
H Horizontal	-S Satin Silver
V Vertical	-B Matte Black

*Doesn't affect price.

CUSTOM MODELS AVAILABLE

Clamp-On

Metal clamp, VEE Clamp design, suitable for round tubes from 7/8" to 1-3/4" and flat surfaces from 5/8" to 2-1/2". 4" riser. Top entry slot.

PX1G	8-1/2" x 11"
PX2G	11" x 14"
PX3G	11" x 17"

Custom clamps available.

Table Top

Weighted 6-3/4" round base, felt feet, 4" riser. Top entry slot.

PX1T	8-1/2" x 11"
PX2T	11" x 14"
PX3T	11" x 17"



Magnetic Mount

Double magnetic base perfect for gondola tops, and other steel surfaces.



PX1D	8-1/2" x 11"
PX2D	11" x 14"
PX3D	11" x 17"



Specify:

Model — Orientation* — Color*
 *Doesn't affect price.

Orientation*	Color*
H Horizontal	-S Satin Silver
V Vertical	-B Matte Black



Tabletop A Frame

Two hinged frames, Top entry, attractive twist chain.

PX1TAF	8-1/2" x 11"
PX2TAF	11" x 14"
PX3TAF	11" x 17"

Stand-Off Kits

Include set of 4 Brackets, wall anchors & screws. All Stand-Offs are 3" long.



SNSO	Snap/Easy Graphic Bar Stand-Off Kit
SOPK	Aluminum Puck Stand-Off Kit
EOSO	Snapframe Stand-Off Kit
PXSO	Perflex Frame Stand-Off Kit



SNSO



PXSO

-S Satin Silver **-B** Matte Black



Wall or ceiling hanging.

Clipster™

Great for posters (.020" max.)

Modern, clean, techy look at a low price point.

Hang vertically or horizontally.

WCF1	5-1/2" x 7"
WCF2	7" x 11"
WCF3	8-1/2" x 11"
WCF4	11" x 14"
WCF5	11" x 17"
WCF6	14" x 22"
WCF7	22" x 28"
WCF8	24" x 36"

-S Satin Silver **-B** Matte Black



Spring tension clips grip poster securely.



Perfex SkyFrames™

STRONG, LIGHTWEIGHT - COST EFFECTIVE

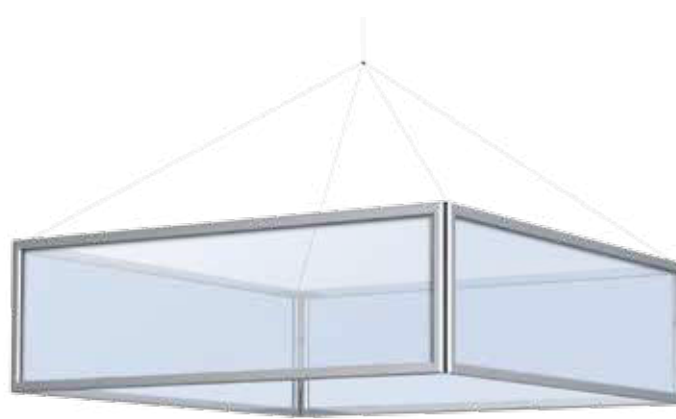
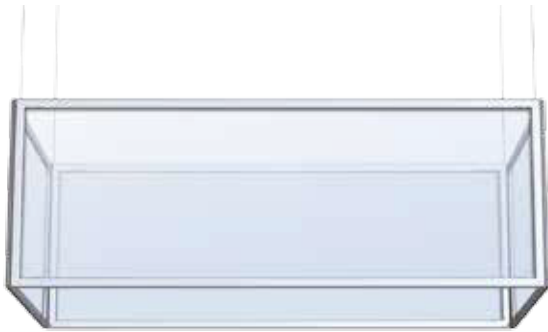

Four Sided Structures

Model:	W x H x D
SRCPX1	42" x 12" x 42"
SRCPX2	48" x 18" x 42"
SRCPX3	48" x 24" x 36"

-S Satin Silver -B Matte Black

Features:

- Contemporary curvilinear design
- Precision mitered corners
- Aluminum alloy construction
- 5 minute assembly
- Integral hanging hooks
- Accepts 3/16" full graphics
- Satin anodized finishes
- Easy side loading

Triangular Structures

Model:	W x H x D
STRPX1	36" x 18" x 36"
STRPX2	42" x 24" x 42"
STRPX3	48" x 30" x 48"

-S Satin Silver -B Matte Black

Aluminum Alloy

Cool curvilinear shape. Precision miters, handsome satin finishes.

Frames accept rigid graphics up to 3/16" full. Lenses are available to "sandwich" thin media.



Live area:
3/8" margin covered by frame.



STEEL HANGING BRACES

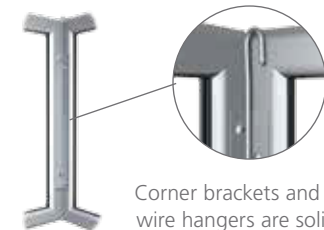

Corner brackets and welded wire hangers are solid steel.

Three and four sided hanging harness sets are available. As is a full range of other hanging hardware.

Perflex Frame Structures™

KIOSKS - 3D TOWERS

Attractive curvilinear alloy frames in handsome satin finishes. Integral steel braces ensure outstanding strength.



Steel support corner brackets insure strength and ease of assembly.



Features:

- Curvilinear profile
- Aluminum alloys
- Satin anodized finishes
- 5 minute assembly
- Top loading
- Accepts 3/16" full graphics

Triangular	Sides	H	Square	Rectangular	W x H x D
TRPX1	24"	x 48"	SQPX1	RCPX1	30" x 48" x 24"
TRPX2	24"	x 60"	SQPX2	RCPX2	30" x 60" x 24"
TRPX3	24"	x 72"	SQPX3	RCPX3	30" x 72" x 24"
TRPX4	30"	x 48"	SQPX4	RCPX4	36" x 48" x 24"
TRPX5	30"	x 60"	SQPX5	RCPX5	36" x 60" x 24"
TRPX6	30"	x 72"	SQPX6	RCPX6	36" x 72" x 24"

-S Satin Silver -B Matte Black

Many other sizes available. Call our friendly sales staff for quotes.



Live area: 3/8" margin covered by frame.



Perfex Swivel Frames™

ALUMINUM SWIVEL FRAMES

All frames are vertically oriented and feature handsome satin finishes.
Holds graphics up to 3/16" thick.



3/8" margin is covered by the frame

< Ceiling Swivels

Includes a 9" standoff and a grid ceiling anchor.

PXCSV1	22" x 28"
PXCSV2	24" x 36"

-S Satin Silver or -B Matte Black

Wall Swivels >

Includes (2) 3" Standoffs and (2) 3-1/4" wall mounts.

PXWSV1	22" x 28"
PXWSV2	24" x 36"

-S Satin Silver or -B Matte Black

Desk Swivels >

Includes a 4" standoff and a 6-3/4" round base.

PXDSV1	8-1/2" x 11"
PXDSV2	11" x 14"
PXDSV3	11" x 17"

-S Satin Silver or -B Matte Black



Strong construction



3/16" full open slots



Precision miters



Fully Adjustable



Create Collage Effects



3/8" margin covered by the frame.



Clear lenses Sold in pairs.

CPL4	11" x 14"
CPL5	11" x 17"

CPL6	14" x 22"
CPL7	22" x 28"

MENU SYSTEM

Offered on a project basis, please contact our friendly sales staff with a sketch of what you would like quoted.



Wide variety of hanging holders.



Live More.

Talk to your pharmacist today.

Learn More >



3/16" full slot, side or top load. For non rigid graphics, use CPL lenses.

Handsome finishes, satin silver or matte black.



SIMPLY TAP TOGETHER FOR VERY EASY ASSEMBLY

Snap-On Perfex Stands™



SNAP ON ALUMINUM FRAMES

Pricing is offered on a project basis, please contact our friendly sales staff with a sketch of what you would like quoted.

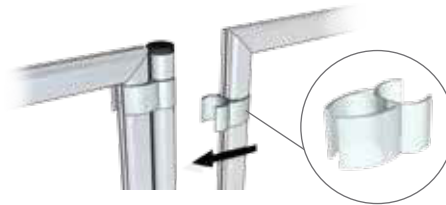

Satin anodized frames, aluminum tubes snap together.

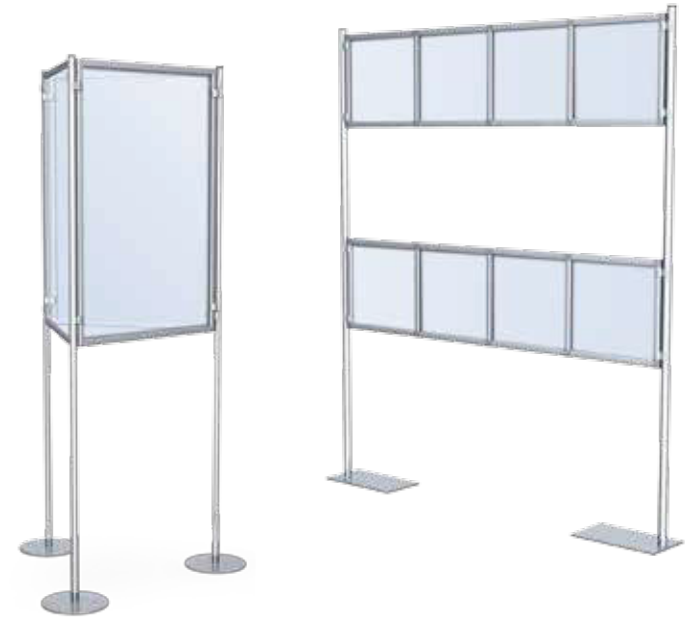

Swing Wing Perfex™

INFORMATION DISPLAYS

Perfect for:

Posters • Prints • Maps • Reference Materials • Sales Collateral

- All metal units
- Satin aluminum
- Built to last
- Pivots top & bottom

CUSTOM MODELS AVAILABLE

Although standard models have 5 or 10 frames per unit, custom units can have any number of frames.



Swing Frame Kiosk™

Easily flip through many posters. Small footprint. 10 satin silver frames. Back entry slots. Room for 3/16" thick materials plus lenses. 20" square base. Height 78". Wt: 55 lbs.

- WINGK1** (10) 22" x 28" frames
- WINGK2** (10) 24" x 36" frames
- WINGK3** (5) 22" x 28" frames
- WINGK4** (5) 24" x 36" frames



Wall Mount SwingWings™

Front mount, 10 satin silver frames. Room for 3/16" thick materials plus lenses. All metal.

- WING01** (10) 22" x 28" frames
- WING02** (10) 24" x 36" frames
- WING03** (5) 22" x 28" frames
- WING04** (5) 24" x 36" frames



TERRIFIC FOR: MUSEUMS - SCHOOLS - RETAIL - TRADESHOWS

Hanging Monster Frames™



STRONG, AESTHETICALLY BEAUTIFUL

- Jumbo aluminum profile
- Handsome matte finishes
- Top 1/4" full entry slots
- 1-1/4" w x 1" d
- Ships fully assembled
- Individually boxed

HANGING OPTIONS:



Metal eye bolts.



Corner brackets with holes.



Custom grid ceiling hanging option with **HD2** clip set.

Specify: Model–Hanging*–Color*

Model	Graphic Size
NSH1	14" x 22"
NSH2	22" x 28"
NSH3	24" x 36"
NSH4	30" x 40"
NSH5	36" x 48"

Hanging*	
WM	Wall Mount
CP	Ceiling Vertical
CL	Ceiling Horizontal

Color*	
-S	Satin Silver
-B	Matte Black

* Doesn't affect price, but must use to order.

HD2 Set of 2 clips. Grips onto frame and holds placards up to 1/8" thick.



Screw ensures miter will never separate.

Clear lenses. Sold in pairs.



CPL6	14" x 22"	CPL7	22" x 28"
CPL6.5	18" x 24"	CPL8	24" x 36"



Full 1/4" top entry slot.



3/8" margin, 1-1/4" wide frame.

Monster Pedestal SignHolders™

GREAT FOR HIGH TRAFFIC VENUES

BUILT TO LAST!

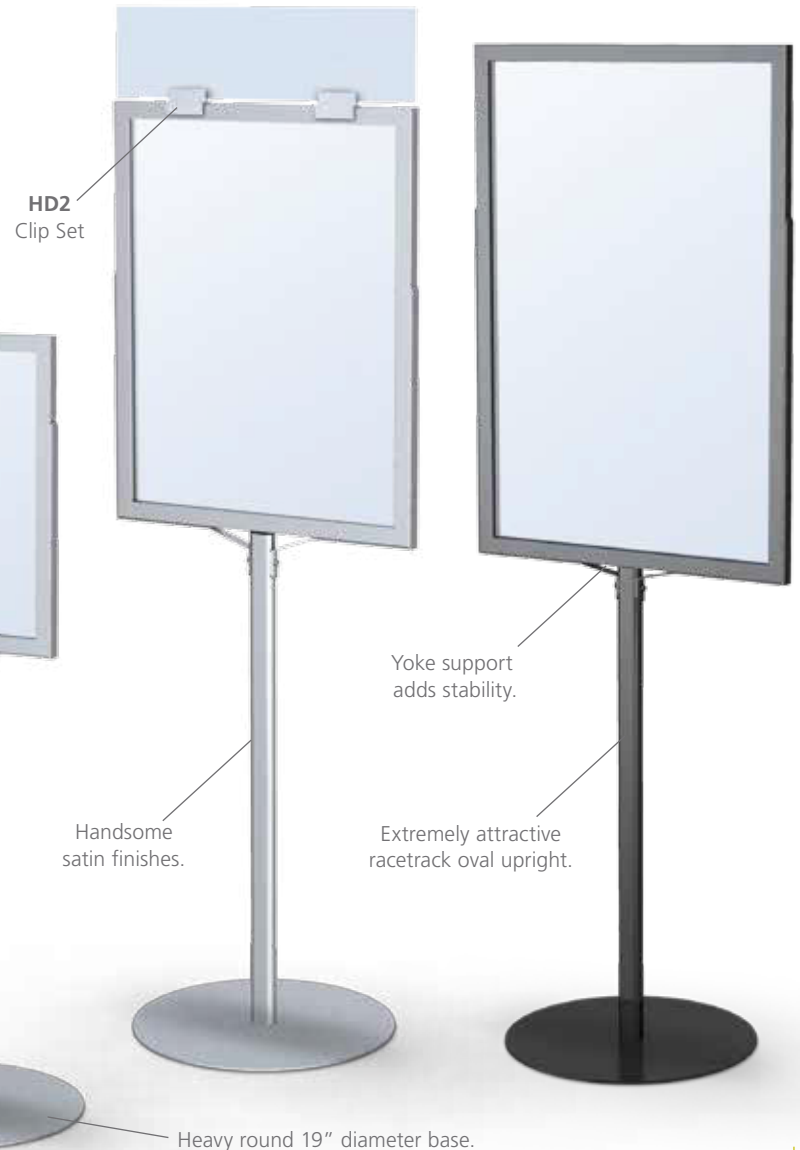

- Wide format alloy frame
- Racetrack oval upright
- 1/4" full top entry slot
- Ultra easy assembly
- 19" round, 15 lb. base
- Handsome matte finishes

NST1422	14" x 22"	59" h	19 lbs.
NST1824	18" x 24"	61" h	20 lbs.
NST2228	22" x 28"	65" h	20 lbs.
NST2436	24" x 36"	73" h	21 lbs.

-S Satin Silver -B Matte Black



< 19" round laser cut 15 lb. steel bases, solid double bolt connection.

Monster Frames™

LARGE FORMAT



HD2 Set of 2 clips. Grips onto frame and holds placards up to 1/8" thick.



MONSTER FRAMES

- Aluminum alloy racetrack oval uprights
- Specially designed heavy-duty alloy frame
- Two nine pound steel bases
- 1/4" full top loading for graphic insertion
- Rock solid double bolt upright to base connection

Frames ship ready to assemble, saving significantly on freight costs.

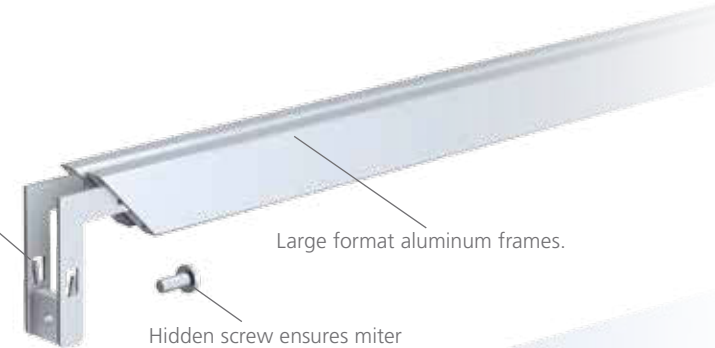

Large format aluminum frames.

Hidden screw ensures miter will never separate.

Textured endcaps.

Beautiful aluminum racetrack oval uprights.

CREATE MONSTER IMPACT!

Specify: Model (Size) - Orientation* - Color*

Model

NSTR1	36" x 48"
NSTR2	36" x 60"
NSTR3	36" x 72"
NSTR4	48" x 48"
NSTR5	48" x 60"
NSTR6	48" x 72"
NSTR7	60" x 60"
NSTR8	60" x 72"

Orientation*

H	Horizontal
V	Vertical

Color*

-S	Satin Silver
-B	Matte Black

*Not on price sheet
must use to order.

All units feature 1/4" full top entry slots.

Frame bottoms are 12" off floor, except 48" high models, which are 24" off floor.

Units ship K.D. ready to assemble.

Estimated assembly time - 8 minutes.

NOTE: Once assembled, units cannot be disassembled.

CUSTOM SIZES AVAILABLE

Units ship K.D.
ready to assemble.
Significant freight savings.



Racetrack oval
uprights

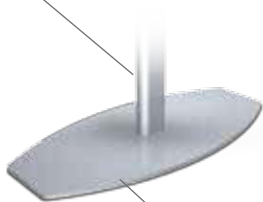

Frames are 1/4" full top load
and 3/8 margin is covered
by the frame.

Specially designed
heavy duty frame.

Marquise Base
18" long, 8-3/4" in the center
laser cut steel bases, solid double bolt connection.

Futura Perflex SignFrames™

Features:

- Sleek aluminum mitered frame
- Handsome satin finishes
- 1-1/2" diameter x 66" tall pole
- 13" Round, 7 lb. base
- Solid security base bushing
- Top entry slot



Easy assembly.
All metal construction.
Single frame option.



Curvilinear Shape.
Accepts 3/16" full substrates with
room for protective clear lenses.

**PRECISION
MITERED CORNERS**



Custom
models
available.



FSP331-S



13" round base with
metal bushing for added stability.

FSP221	22 x 28"	1 Frame
FSP222	22 x 28"	2 Frames
FSP331	24 x 36"	1 Frame
FSP332	24 x 36"	2 Frames

Specify Color*

-S Satin Silver **-B** Matte Black

*Does not affect price

Clear lenses
sold in pairs.

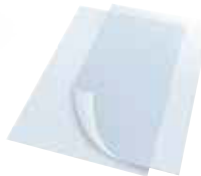

CPL7	22" x 28"
CPL8	24" x 36"



Live area:
3/8" margin is
covered by the frame.

Pamphlet Holders

4" wide by 2" deep pamphlets
9" wide by 2" deep catalog



PB3C



PB4C

MOUNT AND CHANGE GRAPHICS EFFORTLESSLY



Double frames attach easily to upright. View from both sides.



Live area: 3/8" margin is covered by the frame.

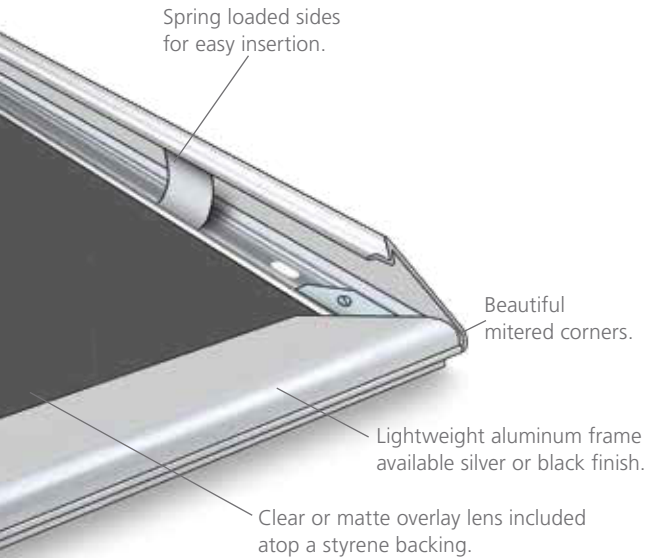

ULTRA CONVENIENT - FRONT LOADING!

Features:

- Aluminum Snap Frame
- Styrene back
- Clear or matte overlay lens included
- Handsome satin finishes
- 13" Round 7 lb. base
- Solid security base bushing
- Jumbo 1-1/2" diameter x 66" tall pole



Mitered Corners.



Radius Corners.

Mitered Corners

FME221	22" x 28"	1 Frame
FME222	22" x 28"	2 Frames
FME331	24" x 36"	1 Frame
FME332	24" x 36"	2 Frames

Radius Corners

FEO221
FEO222
FEO331
FEO332

Specify: Color* –Lens*

Color*

-S	Satin Silver
-B	Matte Black

Lens*

-C	Clear
-M	Matte

*Does not affect price.

Radius Snapframes accept substrates up to 1/8" thick, whereas our mitered units accept substrates only up to 1/32".

Pamphlet Holders

4" wide by 2" deep pamphlets
9" wide by 2" deep catalog



PB3C



PB4C



13" round base with metal bushing for added stability.



FEO331-S-C

CUSTOM MODELS AVAILABLE!

Poster SignHolders

22" X 28" DOUBLE SIDED VIEWING

Features:

- Aluminum construction
- Ultra easy assembly
- Top slot for easy insertion
- Handsome satin finishes
- Room for two 1/8" x 22" x 28" graphics

LF228 Double pole rectangular base 60" h 13 lbs.

-S Satin Silver -B Matte Black



LF228-B

LF228-S



All units top load.

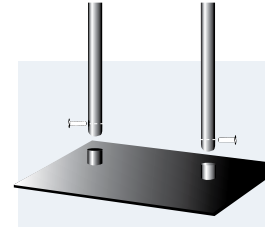

Bases have metal support bushings.

Accessories:



HD1 Clip Set (3) grips up to 1/8". Header not included.

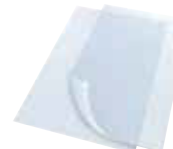

CPL7 22" x 28" Clear lenses Sold in pairs.



SLB Lit. Baskets 11" x 17" tabloids or two 8-1/2" x 11" side-by-side stacks.



LF228-S with **SLB** Lit. basket & **HD1** header clips.



LF2LT3-S
with HD1

CLIP ON COLLATERAL HOLDERS

Crystal Clear Plastic

Pamphlet Holders are 4-3/8" wide x 1-1/2" deep

Catalog Holders are 9-1/4" wide x 1-1/2" deep

Includes pocket dividers that separate cavity for pamphlet use.



Catalog Holders include a removable divider.

1 OR 2 SIDED INFORMATION CENTERS

Features:

- Aluminum construction
- Ultra easy assembly
- Top slot for easy insertion
- Handsome satin finishes
- Room for two 1/8" x 22" x 28" graphics

LF2LT1 Signholder with 5 Pamphlet Holders on 1 side.

LF2LT2 Signholder with 10 Pamphlet Holders, 5 each side.

LF2LT3 Signholder with 2 Catalog Holders on 1 side.

LF2LT4 Signholder with 4 Catalog Holders, 2 each side.

-S Satin Silver -B Matte Black



LF2LT1-B

Titan Poster SignHolders™

TITAN POSTER SIGNHOLDERS™

EXTRAORDINARILY STRONG, STABLE & YET PORTABLE.

Features:

- All Aluminum construction
- Ultra easy assembly in minutes
- Top slot (1/4") for easy insertion
- Handsome satin finishes
- Room for two 1/8" x 22" x 28" or 24" x 36" graphics

Model	Style	Base	Graphics	Ht.	Wt.
LF128	Single Pole	17" Round	(2) 22" x 28"	65"	22 lbs.
LF136	Single Pole	17" Round	(2) 24" x 36"	65"	23 lbs.

-S Satin Silver -B Matte Black



Graphics top load.



Metal yoke insures structural integrity.



Radius corners are aesthetically beautiful.



Laser cut round base double bolt connection.



Beautiful racetrack oval upright.

EXTREMELY STRONG, AESTHETICALLY BEAUTIFUL



Suitable for high traffic areas.



OPEN FRAMES
TWO-SIDED
VIEWING

LF128-S

Accessories:



HD1 Clip Set (3)
grips up to 1/8".
Header not included.



Clear lenses
Sold in pairs.
CPL7 22" x 28"



SLB Lit. Baskets
11" x 17" tabloids or two
8-1/2" x 11" side-by-side stacks.

Poster SignHolders

LF328 - POSTER SIGNHOLDERS

- All Aluminum construction
- Top slot (1/4") for easy insertion
- Room for two 1/8" x 22" x 28" graphics
- Ultra easy assembly in minutes
- Handsome satin finishes
- Height: 63" • Wt: 11 lbs.

-S Satin Silver -B Matte Black



LF328-B

Electrically-welded, all metal extremely durable construction.



LF328-S with SLB3 & HD1



HD1 Clip Set (3) grips headers up to 1/8".

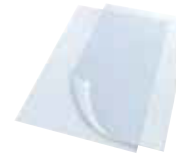

Clear lenses Sold in pairs. CPL7 22" x 28".



SLB3 Lit. Baskets hold (1) 11" x 17" tabloids or (2) 8-1/2" x 11" stacks.



Weighted Cover for LF3's. 21 lb. Sits atop base. LFWC1 -S Silver -B Black



LF3LT3-B with HD1 Clip Set (3) grips up to 1/8". Header not included.

Communication Centers

COLLATERAL SIGNHOLDERS

- Terrific quality, all metal LF3 22" x 28" Signholder
- Crystal clear plastic compartments
- Pamphlet Holders are 4-3/8" wide x 1-1/2" deep
- Catalog Holders are 9-1/4" wide x 1-1/2" deep, includes pocket dividers for pamphlet use.



Catalog Holders include a removable divider dart.



Units attach to signholders by simply clipping onto crossbar.

UNITS ARE 63" HIGH

Those with Holders on 1 side are 13 lbs.
Those with Holders on 2 sides are 15 lbs.



LF3LT1-S

- LF3LT1** 5 Pamphlet Holders on 1 side.
- LF3LT2** 10 Pamphlet Holders, 5 each side.

- LF3LT3** 2 Catalog Holders on 1 side.
- LF3LT4** 4 Catalog Holders, 2 each side.

-S Satin Silver -B Matte Black

INFO CENTERS

- Great quality, economical price point
- Aluminum construction
- Electrically welded bases
- Clear plastic holders
- Pamphlet & catalog sizes
- Back to back displays

- LFPB140** Room for 40 Pamphlets
- LFPB216** 16 catalogs or 32 pamphlets

-S Satin Silver -B Matte Black



Clips (3) included holds headers to 1/8" thick.

LFPB216-B

LFPB140-S

Poster SignHolders

GREAT FOR LARGE VENUES

- Lightweight aluminum construction
- Electrically welded bases with steel inserts
- Satin powder coated matte finishes
- Extremely portable yet durable
- Great for fast and easy graphic change-outs
- Load graphics facing out-both sides



TLT33-B



L2284-B



L2256-S



L2328-S



L3328-S

Model	Capacity	Ht.	Wt.
L2256*	(2) 22" x 56"	62"	12 lbs.
L2284*	(2) 22" x 84"	88"	13 lbs.
L2328	(4) 22" x 28"	63"	12 lbs.
L3328	(6) 22" x 28"	89"	14 lbs.

*Require rigid media, 1/4" max.

-S Satin Silver -B Matte Black

Model	Type	Capacity	Ht.	Wt.
TLT31	1-tilter	(2) 22" x 28"	67"	11 lbs.
TLT32	2-tilter	(4) 22" x 28"	67"	13 lbs.
TLT33	3-tilter	(6) 22" x 28"	89"	14 lbs.

Weighted Covers

LFWC1 21 lbs. - LF328, LFPB, L2256, L2328-S
LFWC2 28 lbs. - L2256, L2284, L3328



CPL7 22" x 28"
 Clear lenses (pairs).

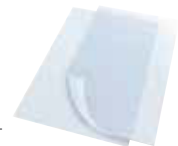

ECONOMY FOLDING A FRAMES

- Aluminum frames, legs and stays
- Units collapse & fold
- 2-1/2" x 2-1/2" x 44-1/2" closed
- Accepts graphics up to 1/4" thick
- Top entry slot, non-slip tips
- Weight only 5-1/2 lbs.

Hold substrates up to 1/4" thick.



AF24-S Opened

Food service, promotional messages, retail signage and more.



AF22 Closed



AF22 Half open



Top load slots.

Extruded aluminum legs have built in frame rails.

Collapsible side, front and back crossbars.

Non-slip tips.

AF22-S	22" x 28"	AF22-B	22" x 28"
AF24-S	24" x 36"	AF24-B	24" x 36"

-S	Satin Silver
-B	Matte Black

Note: Black units are more costly than the silver.

Perfex A Frames

DOUBLE SIDED, FULLY ASSEMBLED.

- Perfex aluminum curvilinear frames
- Aluminum extruded legs
- Ruggedly built - designed to last
- Heavy duty support stays
- Non-skid rubber bumpers
- 44-1/2" Closed, 43" Open



Standard models top load.

AFP22-S



Cool Curvilinear Shape.
Accepts 3/16" substrates with room for protective clear lenses.

Standard		with Headers	
AFP22-S	22" x 28" Silver	AFPH22-S	
AFP22-B	22" x 28" Black	AFPH22-B	
AFP24-S	24" x 36" Silver	AFPH24-S	
AFP24-B	24" x 36" Black	AFPH24-B	

-S Satin Silver or -B Matte Black*
*Black units are more costly than the silver.



AFPH22-S

Header graphic size:
22" x 8" or 24" x 8".

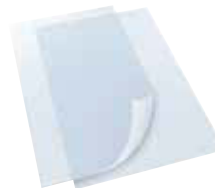

Clear or Matte lenses. Sold in pairs.

CPL7 Clear	CPM7 Matte	22" x 28"
CPL8 Clear	CPM8 Matte	24" x 36"



Live area: 3/8" margin covered by the frame.

A Frame SnapFrames

ULTRA CONVENIENT - FRONT LOADING



All units are double sided and fully assembled.

- Easy-Open Snap Frames
- Styrene back
- Clear or matte overlay lens included
- Non-skid rubber bumpers
- Heavy duty support stays
- 44-1/2" Closed, 43" Open

Mitered Corners

AME22-S	22" x 28" Silver
AME22-B	22" x 28" Black
AME24-S	24" x 36" Silver
AME24-B	24" x 36" Black

Radius Corners

AEO22-S	
AEO22-B	
AEO24-S	
AEO24-B	

Specify: Color-Lens*

Color

-S	Satin Silver
-B	Matte Black

Lens*

-C	Clear
-M	Matte

Black units are more costly than the silver.

*Does not affect price.

Mount and change graphics effortlessly.



AEO24-S



Clear or matte overlay lens included atop a styrene backing.

Spring loaded sides for easy insertion.

Beautiful mitered corners.

Lightweight aluminum frame available in a silver or black finish.

Radius Snapframes accept substrates up to 1/8" thick, whereas our mitered units accept substrates only up to 1/32".



Live area: 3/8" margin covered by the frame.

Convex Poster SignHolders

Extremely easy front graphic installation.



VX1-B



VX1-S

ATTRACTIVE CURVED UNITS DEMAND ATTENTION

Graphic changes are effortless and assembly is ultra simple.

Suitable for high traffic areas.

Convex Poster SignHolders

Dramatic, stylish, elegant two sided curved design. Perfect for exhibits, retail, restaurants, trade shows and malls.

Accepts semi-rigid or rigid self supporting 22" x 28" graphics up to 1/16" thick. Styrene is ideal.

Change out graphics instantly without disassembling unit!

Use .040" semi rigid media minimum, 1/16" (.060") suggested.

1/2" margin on each side, viewable live area 21" wide.

Model	Style	Base	Graphics	Ht.	Wt.
VX1	Single	17" Round	(2) 22"x 28"	66"	19 lbs.
VX2	Double	Elliptical	(4) 22"x 28"	58"	18 lbs.
VX3	Triple	Elliptical	(6) 22"x 28"	86"	23 lbs
VX4*	Long	Elliptical	(2) 22"x 56"	57"	16 lbs.
VX5*	Extra-Long	Elliptical	(2) 22"x 84"	85"	21 lbs

-S Satin Silver

-B Matte Black

*VX4 & VX5 require .060" (1/16") semi rigid media, thinner will collapse. HIPS Styrene ideal. Maximum .090" (3/32").



VX2-B

QUICK CHANGE GRAPHICS - DOUBLE SIDED VIEWING!

Convex Poster SignHolders

MODERN CONTEMPORARY LOOK

Convex signholders have strong visual impact.
Extremely easy front load graphic installation & change out.



VX4-S



*VX4 & VX5 require .060" (1/16") semi rigid media, thinner will collapse. HIPS Styrene ideal. Maximum .090" (3/32").

DOUBLE AND TRIPLE UNITS HAVE ELLIPTICAL BASES



VX5-S



VX3-S

Convex Wall Mount SignHolders

CURVED UNITS DEMAND ATTENTION

Convex Poster SignHolders

Standard Poster size. Dramatic, stylish, elegant curved design.

Wall Mount



CounterTop

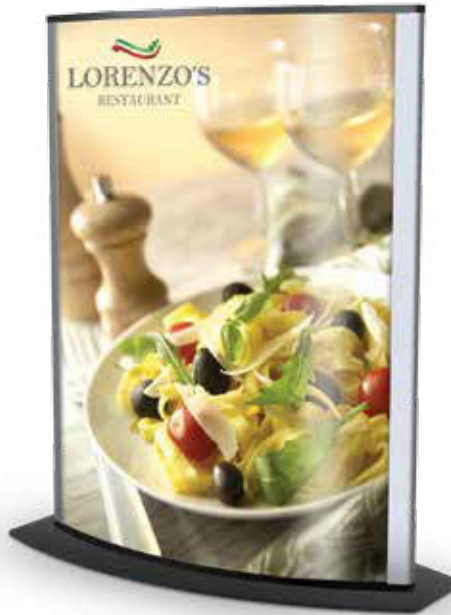

Accepts semi-rigid 22" x 28" graphics in an attractive curved shape.
We strongly recommend you use .060" Styrene.

Graphic changes are effortless and assembly is ultra simple.

Wall mount units include brackets, anchors and screws.

Wall Mount	CounterTop	Size	Color
VXWM1	VXCT1	22" w x 28" h	-S Satin Silver
VXWM2	VXCT2	22" w x 28" h	-B Matte Black

Eclipse Wall Mount™

Accommodates standard paper sizes.



Hanging hardware and lens included.

Custom sizes available.

WE1	11" w x 8-1/2" h
WE2	8-1/2" w x 11" h
WE3	14" w x 11" h

WE4	11" w x 14" h
WE5	17" w x 11" h
WE6	11" w x 17" h

Specify:

-S Satin Silver -B Matte Black

PERFECT FOR EXHIBITS, RETAIL,
RESTAURANTS AND MALLS.

Plastic lenses

Sold in pairs.

Clear	Matte	Size
CPL3	CPM3	8-1/2" x 11"
CPL4	CPM4	11" x 14"
CPL5	CPM5	11" x 17"
CPL6	CPM6	14" x 22"
CPL6.5	CPM6.5	18" x 24"
CPL7	CPM7	22" x 28"
CPL8	CPM8	24" x 36"

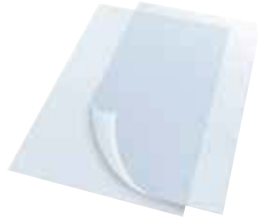

Coroplast® Backs

White, 4 mm corrugated plastic boards make excellent frame backs. Sold individually.



COR3	8-1/2" x 11"
COR4	11" x 14"
COR5	11" x 17"
COR6	14" x 22"
COR6.5	18" x 24"
COR7	22" x 28"
COR8	24" x 36"

Coroplast® - Lens Combo Packs

Includes one 4 mm corrugated plastic board and two clear lenses.

Clear	Matte	Size
COPL3	COPM3	8-1/2" x 11"
COPL4	COPM4	11" x 14"
COPL5	COPM5	11" x 17"
COPL6	COPM6	14" x 22"
COPL6.5	COPM6.5	18" x 24"
COPL7	COPM7	22" x 28"
COPL8	COPM8	24" x 36"



GREAT FOR MALL USE!



ATLAS1 28" w x 78" h x 18" d Specify: **-S** Satin Silver **-B** Matte Black



nema

MARKETING & DESIGN AGENCY

NEMA ASSOCIATES INC.

THE **DISPLAY FOLIO**
Exhibit & Display Catalog

(908) 275-3840

408 E ELIZABETH AVE. LINDEN, NJ 07036

Visit www.nemadesign.com to view or download a digital copy of this catalog.