

Imagine the possibilities...



THE **DISPLAY** FOLIO
Exhibit & Display Catalog



Nema Associates Inc.
408 E. Elizabeth Ave. Linden, NJ 07036
(908) 275-3840

DISPLAY FOLIO[®]

Exhibit & Display Catalog

In the demanding environments where display products are relied on day after day, customers increasingly recognize the importance of quality and of having a partner who can support their evolving needs.

Whether you need one stock item or five thousand custom frames, we are committed to being your source for quality and value in visual merchandising.

We continue to invest to improve the quality of the products and services we deliver to you, our customers. It takes a team effort from our employees, whose priority is ensuring that your projects are successful. Our approach has always been to listen carefully to our customers, and to deliver products that meet your evolving display needs. We service a wide range of industries.

We are proud of our extraordinary reputation for quality, value and reliability. We source the finest quality components, and because we manufacture in the U.S., our supply chain is shorter, "greener", and we can offer customizable solutions tailored to your needs. We are excited about our future and look forward to continuing our pursuit of opportunities together!

Pro iPad Stands*

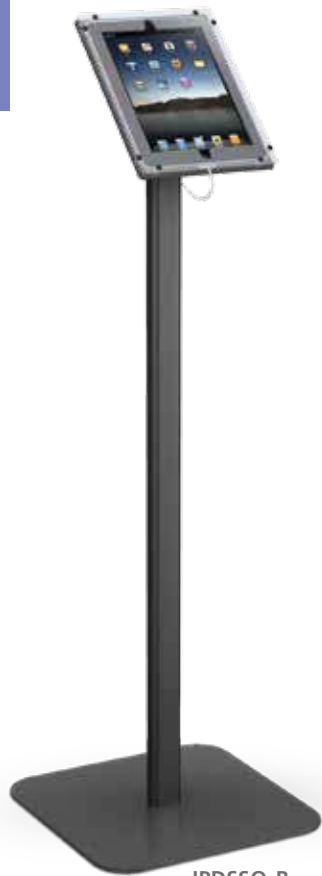

IPDSSQ-B



IPDSRD-S

Pro iPad Stands

- Rotates from portrait to landscape
- Anti-theft hardware
- Metal back, uprights & bases
- High impact acrylic cover
- Included USB cable runs from the top, through the upright, down to the base
- Satin silver or matte black finish

Integral USB cable set included with all units.



Indicate model or USB cable required.

Custom quantity quotes available for any brand tablet or device.

Customization in quantity is our speciality.

Note: Not compatible with iPad 1 or iPad Mini.

Classic Pro iPad Stand

- Oval 37" high aluminum upright
- 13" round or 14" square steel base
- Weight: 11 lbs.

Specify: Model - Base* - Color*

Model

IPDS Floor Stand

Base*

SQ 14" Square

RD 13" Round

Color*

-S Satin Silver

-B Matte Black

Indicate tablet model (iPad 2, 3 or Air) or USB cable required (30 pin or lightning).

*Does not affect price.

IPDSHC - Complete Kit

Stand with Hard Case & custom designed polyethylene inserts for portability & storage.

Specify: **IPDSHC** - Base* - Color*



Tamper proof screws ensure secured enclosure.

360° Swivel
Rotates from portrait to landscape.



Pro iPad Stands*

MADE IN U.S.A. VALUE & RELIABILITY!

Classic Countertop / Wall iPad Stands
8" long post, 11" round or double flange base.

Wall Mount



IPDTW-S

CounterTop



IPDTR-S

Double Flange Base



IPDTF-S

360° Swivel
Rotates from portrait
to landscape.



Eye-Catching Digital
& Graphic Display
Presentations

All Metal Backs,
Uprights & Bases



Tamper proof screws
ensure secured enclosure.

Eclipse Pro iPad Stand

- Curved 43" h upright
- Welded construction
- Oval 9" x 14" base
- Weight: 10 lbs.



IPEC-B



IPEC-S

Specify: Model - Color*
Model

- IPDTR** Counter Top, 11" Round Base
- IPDTF** Double Flange Base
- IPDTW** Wall Mount

- Color*
- S** Satin Silver
 - B** Matte Black

*Does not
affect price.

IPEC Curved Floor Stand

- S** Silver
- B** Black

Indicate tablet model (iPad 2, 3 or Air) or USB cable required (30 pin or lightning).

Mercury Retractable iPad Stands™

COMBINING OUR MERCURY RETRACTABLE WITH A TABLET DISPLAY

Hybrid Pro Mercury Tablet Stands

- Tablet rotates from portrait to landscape
- Anti-theft hardware
- Metal back, upright & base
- High impact acrylic cover
- Included USB cable runs from the top, through the upright, down to the base
- Satin silver or matte black finish

Integral USB cable set included with all units.



Indicate model or USB cable required.

Custom quantity quotes available for any brand tablet or device.

Customization in quantity is our speciality.



Tamper proof screws ensure secured enclosure.

IPRY1-S-HC
hardcase kit



Specify: Model - Tablet* - Color*

Model	Description	Banner Width
IPRY1	single sided	36"
IPRY1-HC	single sided w/hard case	36"
IPRY3	single sided	24"
IPRY3-HC	single sided w/hard case	24"

Tablet* (same cost)

-A	iPad Air (Models 1 & 2)
-I	iPad (Models 2 & 3 only)

Color* (same cost)

-S	Satin Silver
-B	Matte Black

Retractable accommodate many types of media substrates- vinyl, fabric, laminated film and more.*

*15 mil max. Laminate one side only. Must be pliable to roll up tightly.

Note: Pro iPad and Hybrid Pro Tablet Stands not compatible with iPad 1 or iPad Mini. Tablets not included.



IPRY1-I-S with **LEDBR1** light.



IPRY1-I-B

Mercury Retractable Features

- Infinite height adjustments 36" to 96"
- Very lightweight & portable
- Instant set-up and take-down
- Telescopic pole system
- Aluminum construction
- Satin finishes

Hybrid Pro iPad Stands™



IPHB2-S

IPHB2 Holds 24" wide hemmed banners/. Use 1 or 2 sided. Telescopic pole accommodates banners up to 96" high. Weight: 14 lbs.

-S Satin Silver **-B** Matte Black

Custom models available in quantity.



IPHC2-S

Moveable aluminum clamps along 72" high aluminum pole. Holds rigid & semi-rigid graphics up to 1/2" thick.

Model	Style	Wt.
IPHC1	Single sided (2 clamps)	15 lbs.
IPHC2	Double sided (4 clamps)	15 lbs.

-S Satin Silver **-B** Matte Black



IPF2E07-S

Drop In Perfix Frames



SnapFrames

Front load, includes matte lens & styrene back.



Laser Cut Bases

10" x 14" oval. 7 lbs. Double bolt rock solid connections.



IPF2PX9-S

Note: Pro iPad and Hybrid Pro iPad Stands not compatible with iPad 1 or iPad Mini.

IPF Aluminum Frames are moveable along the 72" high upright. Choose either top load drop in frames or easy open front load SnapFrames.

Specify: Model – Frame Style – Color * *Does not affect price.

Model	Drop in Frame	Snap Frame	Color*
IPF1	1 Frame PX5 22 x 28	EO7 22 x 28	-S Satin Silver
IPF2	2 Frames PX6 24 x 36	EO9 24 x 36	-B Matte Black
	PX9 22 x 56	EO12 22 x 56	

Aluminum Slatwall

Bulk Slatwall — 1" on Center, Satin Anodized

Aluminum etched and satin anodized complements all environments.

- 1" on center aluminum alloy
- Etched & clear satin anodized
- Lightweight & strong
- Beautiful, modern design



Single Sided

Single Sided	Double Sided	Dimensions
LUMA48	LUMD48	6" high x 48" long
LUMA72	LUMD72	6" high x 72" long
LUMA96	LUMD96	6" high x 96" long
LUMA144	LUMD144	6" high x 144" long

Other lengths available.

6" high profiles nest together.
Height is a multiple of 6" plus 1/4".

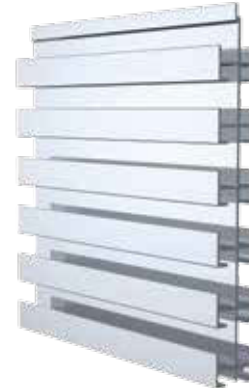

Double Sided

Tons of standard accessories fit our slatwall:

- Lit. Holders
- Jewelry Displays
- Shelf Brackets
- Face Outs
- Baskets
- Signage
- Shelves
- Hangers
- Hooks
- Hat Racks
- Cap Displays
- Waterfalls

Single Sided Wall Mount Panels

All aluminum, clear satin anodized. Handsome finishing trim on two sides. Accepts all standard slat wall accessories.

Model	W" x H"	Model	W" x H"
LUM2412	24"x 12-1/4"	LUM4818	48"x 18-1/4"
LUM3612	36"x 12-1/4"	LUM6018	60"x 18-1/4"
LUM4812	48"x 12-1/4"	LUM2430	24"x 30-1/4"
LUM6012	60"x 12-1/4"	LUM3630	36"x 30-1/4"
LUM2418	24"x 18-1/4"	LUM4830	48"x 30-1/4"
LUM3618	36"x 18-1/4"	LUM6030	60"x 30-1/4"



Custom
Requests
Encouraged

Revolver Slatwall Stands

Modern and contemporary, 1" on center slatwall, satin anodized finish.

- Lazy Susan Swivel Base
- Saves on Floor space
- Double Sided
- Great for retail



Model	Dimensions
LUR54	16" Diam. Base x 54" high
LUR72	16" Diam. Base x 72" high

Portable Slatwall Stands

BEAUTIFUL SATIN FINISH

Contemporary
Modern
Look

- Lightweight & strong
- Etched & clear satin anodized
- Welded steel bases
- Racetrack oval upright
- Locking Casters
- Ultra easy assembly

Custom
Requests
Welcomed



LUP11H



LUP11

Lockable casters
are included

Headers accept
22" w x 8" h graphics



Units top load



LUP22

Rolling Base Assemblies are:
25" w x 21-1/4" d x 4" h

LUP11	One-sided Slatwall	70" h	LUP12H	Two-sided with header	70" h
LUP11H	One-sided with header	79" h	LUP22	Two-sided, 22" x 28" frame	70" h
LUP12	Two-sided Slatwall	70" h	LUP22H	Same with header	79" h



LUP22H

Slatwall starts about 16" up from the floor.

Pegboard to Slatwall Change-Out

Change out Lozier® & Madix® Gondolas with Satin Anodized Aluminum Slatwall Back Panels.



Remove pegboard, insert clip at appropriate height on each side. Hang pre-assembled slatwall panel, replace header.



Slatwall panels with brackets ship pre-assembled.

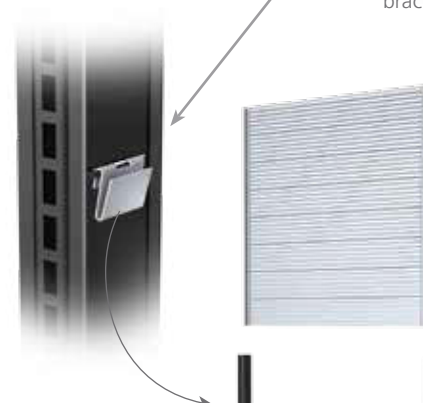

Drop down panel so attached brackets hang from side clips.

Specify: Model - Single or double sided, Brand*

Model	Panel to fit gondola
LUX0	36" x 54"
LUX1	36" x 60"
LUX2	36" x 72"
LUX3	36" x 84"
LUX4	36" x 96"
LUX5	48" x 54"
LUX6	48" x 60"
LUX7	48" x 72"
LUX8	48" x 84"
LUX9	48" x 96"

Specify:

Single or Double sided

-1 Single Sided

-2 Double Sided

Brand*

-Z Lozier

-M Madix

*Does not affect price.

Sizes are from the floor up, including the base.

Aluminum Slatwall Panels

Accessory Slatwall Panels/SignFrames

Panels include laser cut steel brackets for mounting to Lozier or Madix Gondolas.

Perfect when just sections of slatwall are wanted.



Model	Slatwall Size
LUA1	36" x 12"
LUA2	36" x 24"
LUA3	36" x 36"
LUA4	48" x 12"
LUA5	48" x 24"
LUA6	48" x 36"



Also available, Perfix drop-in & SnapFrames, that mount to Lozier or Madix Gondolas.

Power Wing Panels

Create more merchandising space. Includes mounting hardware.

Sturdy, Simple Clip-On Design!



Specify: Model - Left or Right Side, Brand: Lozier or Madix*

Model	Panel Size
LUW1	12" x 48"
LUW2	12" x 60"
LUW3	12" x 72"
LUW4	16" x 48"
LUW5	16" x 60"
LUW6	16" x 72"

Specify:
Left or Right side-(as facing unit)*

-L	Left
-R	Right

Brand*

-Z	Lozier
-M	Madix

*Does not affect price.

Sized from the floor up, including the base.

Create Aisle End Caps

Accepts Standard SlatWall Accessories

Pallet, Catalog & Acrylic Signholders

PLT-1 PALLET SIGNHOLDER



Hooks fixed at 18" centered.

Also use with pole pocket banners, eyebolts are removable.

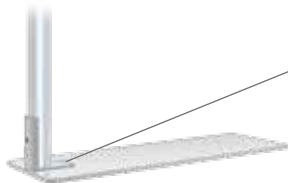

Electrically welded base bracket.

- Telescopic 72" high pole
- 24" long crossbar
- Satin silver finish
- Heavy duty shovel base 3/16" x 4" x 14" thick
- Hooks fixed at 18" centers

CATALOG HOLDERS



- Great for retail showrooms & lobbies
- All metal construction
- 11-1/2" high by 20" wide
- Angled 3-ring binder with pencil edge

Model	Base	Upright
PCS1	13" Round base	1" diameter, straight
PCS2	Oval base	1" diameter, curved

Choose: -S Satin Silver -B Matte Black

TELESCOPIC, ACRYLIC TOP STANDS



- 8.5" x 11"
- Acrylic Holders
- Telescopic poles 26"-50"
- Metal pedestal bases

Specify: Model - Base - Orientation* - Color*

Model

- S4** Slanted
- O4** Open Tray

Base

- SQ** 12" square
- RD** 11" round

Orientation*

- H** Horizontal
- V** Vertical

Color*

- S** Satin Silver
- B** Matte Black

*Doesn't affect price.

Simple & Clamp SignHolders

SIMPLE SIGNHOLDERS

SINGLE SIDED CLAMP STANDS

Adjustable top and bottom holders.

Poles screw together for a seamless look.

Aluminum alloy.

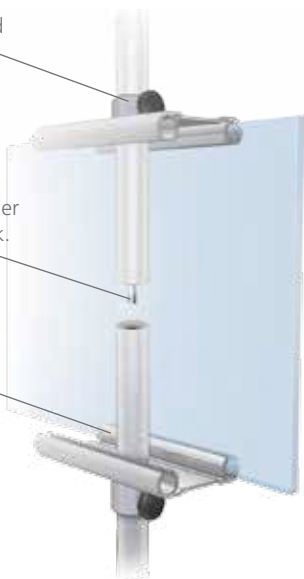

> Hold rigid substrates up to 1/4" thick.

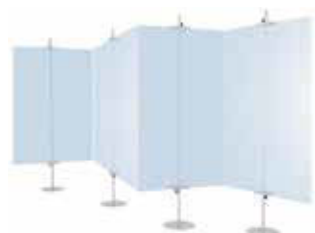

Great as Trade Show Corners.



ES2 extra holders



TB travel base

SS2RD-S with ES2 extra holders.

Specify: Model – Base – Color*

Model	Height	Sections	Diameter	Base	Color*
SS2	72"	2	1"	SQ 12" Square	-S Silver
SS3	96"	3	1"	RD 11" Round	-B Black
ES2 Extra Holders for SS2, SS3 (2/set)				TB Travel	*Doesn't affect price.

- Telescopic pole
- Several base choices
- Two clamp choices

Specify: Pole - Base - Clamp* - Color*

Pole

C2	2 section	38" - 72"
C3	3 section	36" - 96"

Base Steel, weighted bases

SQ	12" square (1/8")	- 5 lbs.
SQ2	16" square (1/8")	- 9 lbs.
RD	11" round (3/16")	- 5 lbs.
RD2	13" round (3/16")	- 8 lbs.

Clamps*

1. Black plastic, opens 1-1/4"
2. Plated steel opens 2"



Colors*

-S Satin Silver	-B Matte Black
-----------------	----------------

*Does not affect price.



C2RD21-S

Contemporary Clamp Stands



VCST1-S

CONTEMPORARY CLAMP STANDS

Featuring:

SOLID ALUMINUM SIGNING CLAMPS



- Solid aluminum alloy
- Anodized satin finishes
- 2" w x 3" h, rubber grips
- Clever binder spring
- Grip range up to 1/2" thick.



- Laser cut 5 pound round steel base
- Choose single or double sided
- Two section aluminum 1" diameter 72" pole assembly
- Choose satin silver or matte black finish

STANDS INCLUDE AN UPPER AND LOWER CLAMP

Extra Clamps:



VCEC1-S



VCEC2-S

SINGLE AND DOUBLE SIDED ALUMINUM CLAMP STANDS

- VCST1** Single sided stand (2 clamps)
- VCST2** Double sided stand (4 clamps)

- VCEC1** Extra Single sided clamp set (2)
- VCEC2** Extra Double sided clamp set (2)

Specify: -S Satin Silver -B Matte Black



VCST2-S



With 17" Round 12 lb. Base

- VCST31** Single sided (2 clamps)
- VCST32** Double sided (4 clamps)

- S** Satin Silver **-B** Matte Black

With Suction Cup Base

Specify: -Model -Top* -Color*

- VPP1** Single sided PortaPole
- VPP2** Double sided PortaPole

- | | |
|-----------------------------|------------------------|
| Top* | Color* |
| SC Suction Cup | -S Satin Silver |
| CG Ceiling Grid Clip | -B Matte Black |

*Does not affect price.

Sometimes 12' isn't high enough.
Extensions attach to the top pole.

- VPP4** 48" extension pole
- VPP8** 96" extension pole



- VCE3** Extra single sided clamp. Set (2)*
- VCE4** Extra double sided clamp. Set (2)*

*One for 1-3/8" & one for 1-1/2" diameter.

- S** Satin Silver **-B** Matte Black

VPP2SC-S VPP1CG-S with VCE3 -S clamp set.

PORTAPOLES

- Opens 12', closes 7'
- Beautiful satin finishes
- Moveable clamp assemblies
- Clamp range to 1/2" thick
- One Clamp for 1-3/8" & one for 1-1/2" diameter poles.



LIGHTWEIGHT & STRONG



VCST31-S

Exhibitor Products

Literature Stands

- Wire baskets hold literature up to 9" wide, leaning invitingly forward
- 1 & 2 sided models: hold either 5 or 10 baskets
- 60" total height
- Attractive black powder coated finish
- Steel 12" square base
- Footprint is only one square foot



LR1



FREE bag with every stand!

Well designed nylon carry bag is included for portable use. Features a special compartment with straps to hold base securely.



LR2

LR1	5 pocket literature stand & bag	11 lbs.
LR2	10 pocket literature stand & bag	12.5 lbs.
EBGLR	Literature stand bag ONLY	3.5 lbs.

Bag Racks

Bag Racks provide attractive advertising. We are now happy to offer telescopic models. 40" high, 24" long arms, finial top. 3 base styles and 2 finishes available. Weight: 6 lbs.



Custom models also available!



TB Travel Base



Round Base option



SBR1 with SWBWL signholder



SWBWL-S Signholder

SBR1	Silver	12" square	SBR8	Black	Travel base*
SBR2	Silver	Travel base*	SBR9	Black	11" round base
SBR3	Silver	11" round base	SWBWL	-B or -S	Wire signholder accessory
SBR7	Black	12" square base	EBGX	*Bag available for travel models	

Telescopic uprights add a -TP example: **SBR1TP** **SWBWL** Specify: -B Matte Black -S Satin Silver

Exhibitor Products

Print Racks

Easy access and storage of unframed prints, posters and paintings. Use in galleries, stores and studios. Print Racks organize space efficiently and cost-effectively.



PR38



PR42



PR63



PR64

Model	Open Size h-w	Construction
PR38	39.5"-24"	Aluminum legs, canvas bed
PR42	39.5"-32"	Aluminum legs, canvas bed
PR63	32"-34"	Welded steel, white enamel finish
PR64	32"-34"	Welded steel, black enamel finish

Projector Stand

Ideal for multi-media presentations. Perfect solution for A-V equipment

MULTIMEDIA SUPPORT

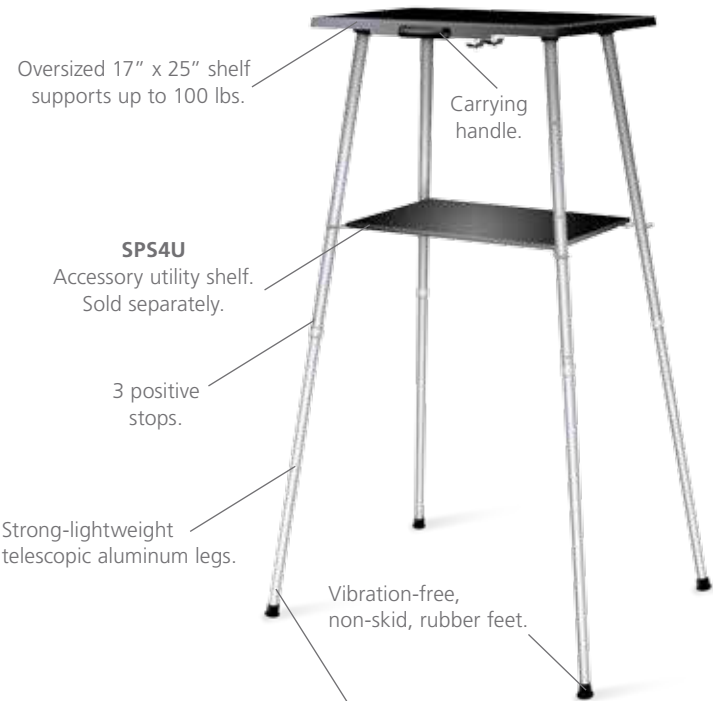

Oversized 17" x 25" shelf supports up to 100 lbs.

Carrying handle.

SPS4U
Accessory utility shelf. Sold separately.

3 positive stops.

Strong-lightweight telescopic aluminum legs.

Vibration-free, non-skid, rubber feet.

Aluminum legs, store under top shelf.

EASY TO CARRY AND SET-UP.



SPS1	Adjusts from 24" to 41"	8.5 lbs.
SPS2	Adjusts from 32" to 56"	9.5 lbs.
SPS4U	Accessory wood utility shelf	4.5 lbs.

Umbrella Stand



Drip pan included.

Wastebasket



Facility Essentials

Suited for offices, lobbies, tradeshow, and other common areas. All metal, quality construction, matte black finish.

Diameter: 10" Height: 15"

60206	Wastebasket
61206	Umbrella stand

Privacy Stands™

PRIVACY FLOOR STANDS

- Aluminum construction
- 75" tall, 2 section uprights
- Graphic clips or crossbars
- Satin anodized finish
- 5 minute assembly
- Steel weighted bases

Clips accept semi-rigid or rigid graphics from .020" to .187" thick.
Styrene is an excellent media choice, as it can be rolled for easy shipping.

ECONOMICAL - EASY ASSEMBLY!

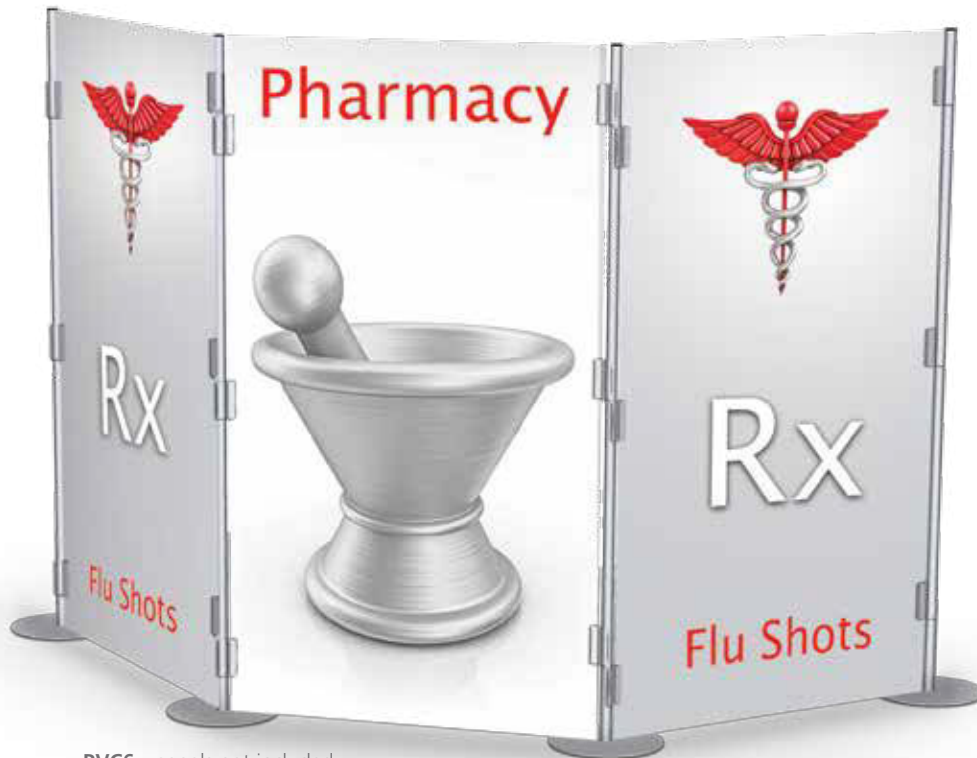

PVC6 - panels not included.



PVC3

9" round laser cut steel bases.



Units that accept 30" Pole Pocket Graphics (3/4" diameter crossbars)

PVC3	3 uprights, 3 bases, 4 crossbars holds 2 graphics
PVC3C	Same but with EBPVC case formatted for storage
PVC4	4 uprights, 4 bases, 6 crossbars holds 3 graphics
PVC4C	Same but with EBPVC case formatted for storage

Snap-on Units for Rigid & Semi-Rigid Graphics

PVC5	3 uprights, 3 bases, 12 clips holds 2 panels
PVC5C	Same but with EBPVC case formatted for storage
PVC6	4 uprights, 4 bases, 18 clips holds 3 panels
PVC6C	Same but with EBPVC case formatted for storage



EBPVC Travel Bags. Carry and store stand components together from one season to the next. Includes special base holder bar.

Table Top Exhibits

TABLETOP EXHIBITS



COH1 Telescopic Clamp-On Header Kit

Model	Uprights	Clips	Holds	Model	Uprights	Clips	Holds
PVT1	4 - 24" High	12	3 panels	PVT3	4 - 36" High	12	3 panels
PVT2	5 - 24" High	16	4 panels	PVT4	5 - 36" High	16	4 panels

- 2 Table clamps open to 2-1/2"
- 2 Telescopic clear anodized uprights
- Good for hemmed banners
- 2 Crossbars telescope from 70" to 96" good for 6' or 8' wide tables. Bottom crossbar snaps on anywhere along upright



Graphics Determine Panel Widths, Matte Silver Finish.
 Clips accepts semi-rigid or rigid graphics from .020" to .187" thick.
 Semi-rigid graphics can be rolled for easy shipping.
 .040" styrene is a perfect choice.



PVCLP
 Pack of 12 extra clips.



Also check out our
 Tension Fabric
 Table Top Displays
 on page 99.





nema

MARKETING & DESIGN AGENCY

NEMA ASSOCIATES INC.

THE **DISPLAY FOLIO**
Exhibit & Display Catalog

(908) 275-3840

408 E ELIZABETH AVE. LINDEN, NJ 07036

Visit www.nemadesign.com to view or download a digital copy of this catalog.