

Imagine the possibilities...



THE **DISPLAY FOLIO**
Exhibit & Display Catalog



Nema Associates Inc.
408 E. Elizabeth Ave. Linden, NJ 07036
(908) 275-3840

DISPLAY FOLIO[®]

Exhibit & Display Catalog

In the demanding environments where display products are relied on day after day, customers increasingly recognize the importance of quality and of having a partner who can support their evolving needs.

Whether you need one stock item or five thousand custom frames, we are committed to being your source for quality and value in visual merchandising.

We continue to invest to improve the quality of the products and services we deliver to you, our customers. It takes a team effort from our employees, whose priority is ensuring that your projects are successful. Our approach has always been to listen carefully to our customers, and to deliver products that meet your evolving display needs. We service a wide range of industries.

We are proud of our extraordinary reputation for quality, value and reliability. We source the finest quality components, and because we manufacture in the U.S., our supply chain is shorter, "greener", and we can offer customizable solutions tailored to your needs. We are excited about our future and look forward to continuing our pursuit of opportunities together!

Straight Flat Walls

PILLOWCASE MOUNTING

Features:

- Durable construction
- Strong, yet lightweight
- Satin anodized aluminum
- Designed for pillowcase mounting
- Quick easy assembly
- Sectional crossbars - uprights
- Heavy 9 lb. steel bases
- 1-1/4" diameter tubing
- Slightly radiused corners

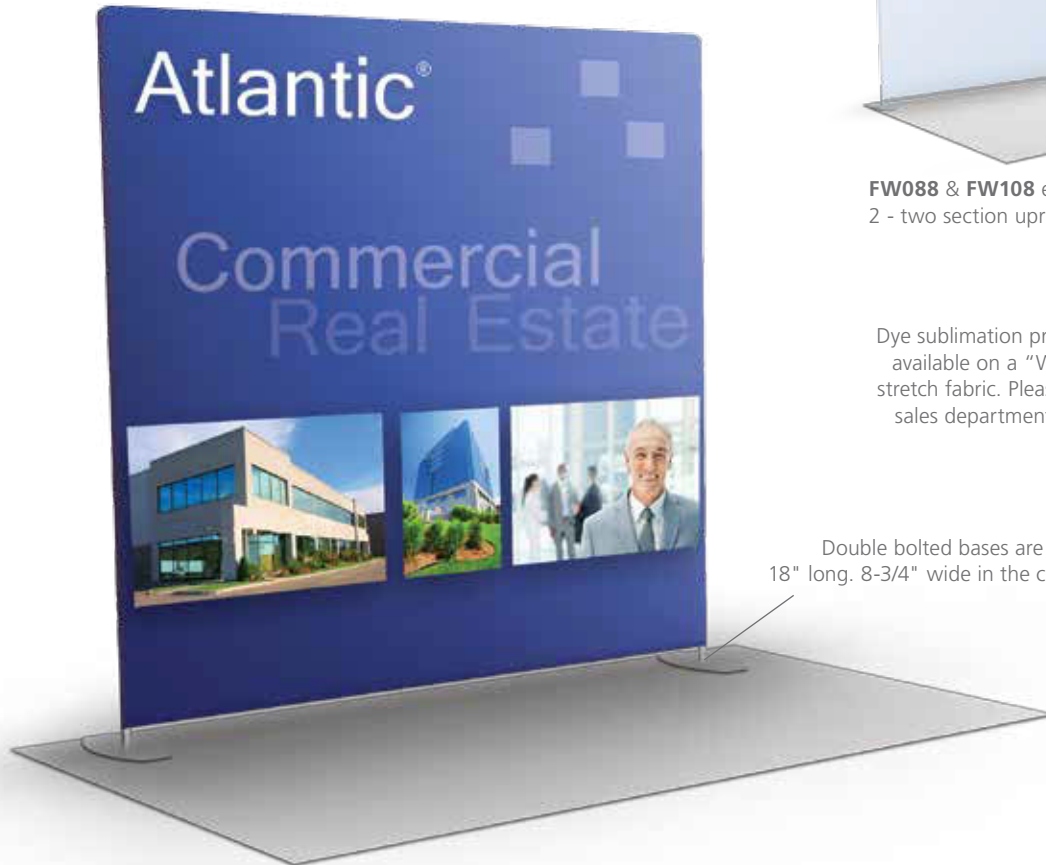

Double bolted bases are 18" long, 8-3/4" wide in the center.

TOOL - FREE ASSEMBLY

LIGHTWEIGHT, STRONG AND PORTABLE

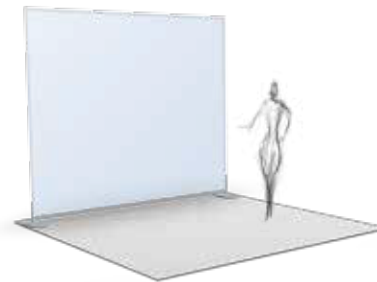

FW088 & FW108 each have 2 bases and 2 - two section uprights & crossbars.

Dye sublimation printed graphics available on a "Wrinkle Free" stretch fabric. Please contact our sales department for pricing.

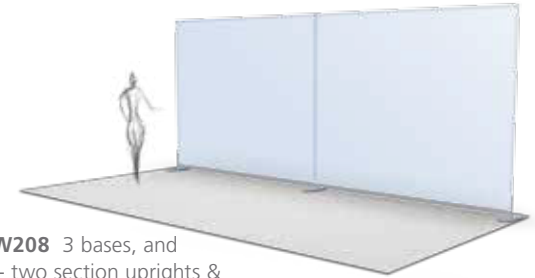

FW208 3 bases, and 4 - two section uprights & 4 - two section crossbars.

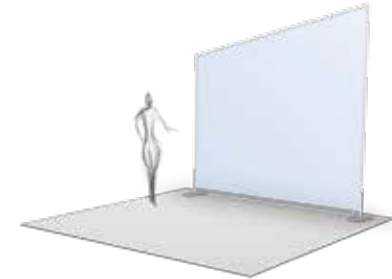

Sloped versions available on a custom basis.

Model	Nominal	Graphic Size
FW088	8' wide x 8' high	96" w x 96" h
FW108	10' wide x 8' high	111" w x 96" h
FW208	20' wide x 8' high	230" w x 96" h



Swage & Spring Button, Tool-Free Assembly



SNB-1 Duffel style bag 33" x 12" x 13". Inexpensive and perfect for carrying unit, and keeping all the components together.

FABRIC DISPLAYS ARE IMPACTFUL!

PILLOWCASE MOUNTING



TOOL - FREE ASSEMBLY

Frame Structures

- 1" constant diameter clear anodized uprights. Sleek design, tubes feature swaged and button construction for quick assembly & portability.
- Laser cut bases lend stability. Double bolted 18" long, 8-3/4" wide in the center.
- Hanging units without bases, with eyebolts are available - contact our friendly sales staff.

Frames	w'	h'	Frames	w'	h'
VG62	2'	6'	VG82	2'	8'
VG63	3'	6'	VG83	3'	8'
VG64	4'	6'	VG84	4'	8'



Swage & Spring Button, Tool-Free Assembly

LIGHTWEIGHT & PORTABLE



Dye Sub Fabric Graphics

- Endless possibilities, custom printed from your artwork, fabulous for visual marketing.
- These pillowcase mount graphics feature an industrial bottom zippered closure for easy assembly.
- Graphics are available 1 sided & 2 sided. See graphic specifications. Light blockers are also available.
- High Impact 720 dpi dye sub printing on a virtually "Wrinkle Free" stretch fabric, One-sided graphics have an opaque backing.



You may also like our [Harmony Banner Stands](#) on pages 124-125.

Classic Graphic Headboards



Pillowcase mounted graphics are beautiful and cost effective.

Fabric graphics can be coordinated with mattress and bedding designs.

Our specialty: Fabrication of custom aluminum frames.

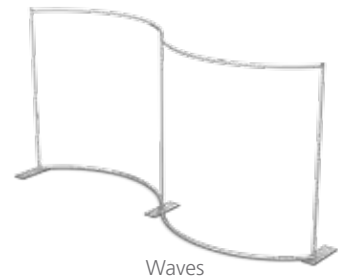
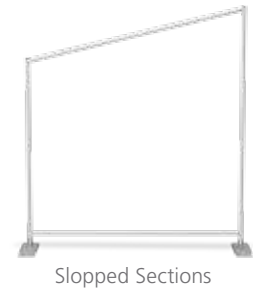

Classic Graphic Headboards

- Designed for pillowcase graphics
- Ships cost efficiently-small carton
- 1" diameter aluminum alloy
- Assembles easily in 5 minutes
- Satin anodized finish
- Height of all units 60"

Model	Width
HB39LS	39" Twin
HB54LS	54" Full
HB60LS	60" Queen
HB72LS	72" California King
HB76LS	76" King



Crest Graphic Headboards

Crest Graphic Headboards

- Use pillowcase graphics
- 1-1/4" diameter alloy aluminum
- Satin anodized finish
- Height of all units 72"
- Ships KD in a small carton
- Amazingly easy to assemble

Model	Width
HB39CR	39" Twin
HB54CR	54" Full
HB60CR	60" Queen
HB72CR	72" California King
HB76CR	76" King

CUSTOM SIZES & MODELS AVAILABLE.

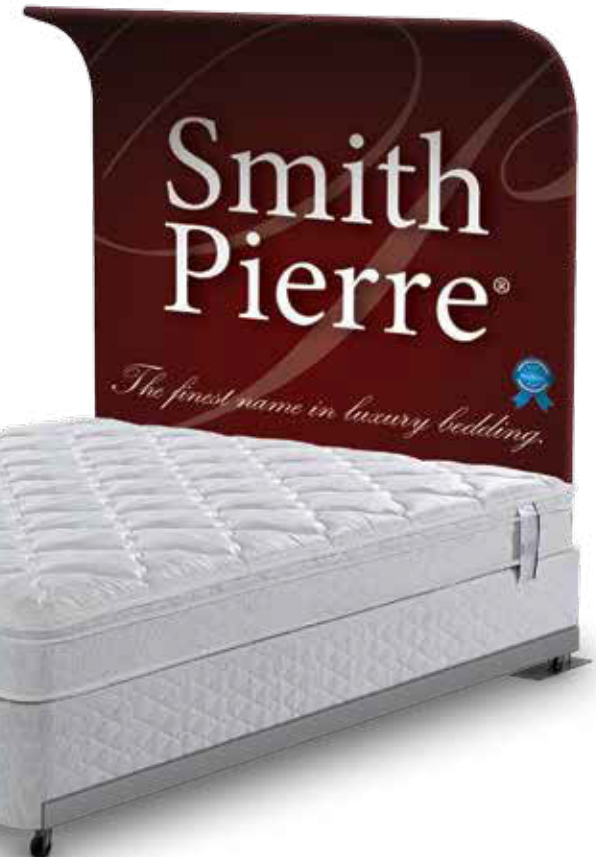

Inner support bushing ensures the structural integrity of the 4" x 18" steel base.



CURVED TOPS ADD EXTRA FOCUS

Cobra and Crescent Stands™

SPACE DEFINERS ENHANCE BRAND AWARENESS!



Uniquely shaped freestanding structures, Cobra and Crescent Stands™ deliver your brand message in impressive style.

- 1" diameter aluminum anodized structure
- Easy 5 minute assembly
- 7' height - 3 widths

Frame Structures

- Lightweight, portable and sturdy, 1" diameter clear anodized tubing made to exacting specifications.
- Extremely easy to set-up and use. Assemble in minutes with coded indicators.

Cobra	Width
CBR2	24"
CBR3	36"
CBR4	48"

140" Approximate Linear Length.

Crescent	Width
CENT2	24"
CENT3	36"
CENT4	48"

91-1/4" Approximate Linear Length.

Note: Due to the complexities of the radii, and because fabrics & sewing techniques vary, please order the frame before graphic preparation.



CBR2



Accessory Bag **EBP-4** holds any size Cobra or Crescent Stand.



CENT2

Tension Fabric Graphics

- Endless possibilities, custom printed from your artwork, fabulous for visual marketing.
- Graphics are available 1 sided & 2 sided. See graphic specifications. Light blockers are also available.
- Pillow case mounting with an industrial zipper closure offers amazing ease of assembly.
- Top quality 720 dpi dye sub printing on a virtually "Wrinkle Free" stretch fabric, designed for this application.

MEGA WAVE FRAME STRUCTURES FEATURE TOOL-FREE ASSEMBLY!!

Lightweight portable and sturdy, frames are constructed of 1-1/4" diameter clear anodized tubing made to exacting specifications. A soft travel bag is included with every frame. Extremely easy to set-up and use. Assemble in minutes with color-coded indicators. Hanging units are available with eyebolts.

Frames	Width		Height	Depth
MG84	8'	117" Approximate Linear Length	4'	17"
MG86	8'		6'	17"
MG88	8'		8'	17"
MG810	8'		10'	17"

MG104	10'	140" Approximate Linear Length	4'	18"
MG106	10'		6'	18"
MG108	10'		8'	18"
MG1010	10'		10'	18"

MG124	12'	155" Approximate Linear Length	4'	20"
MG126	12'		6'	20"
MG128	12'		8'	20"
MG1210	12'		10'	20"

Note: Fabrics differ as do sewing techniques, please order the frame before graphic preparation.



SNB1

SNB1 (imported): Soft nylon bag keeps elements together, **FREE** with every Mega Wave Wall. 33" x 12" x 13".



Swage & Spring Button,
Tool-Free Assembly

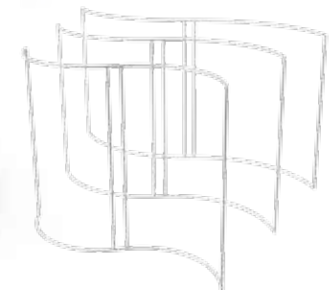

Mega Wave Tension Graphics

- Endless possibilities, custom printed from your artwork.
- Top quality 720 dpi dye sub printing on a virtually "Wrinkle Free" stretch fabric, designed for this application.
- Produce fabulous visual marketing effects.
- Pillow case mounting with an industrial zipper closure offers amazing ease of assembly.
- Graphics are available 1 sided & 2 sided. Light blockers are also available.

Cool C Walls™

ENHANCE BRAND AWARENESS!

- Lightweight portable and sturdy
- Assemble in minutes with coded indicators
- 1-1/4" diameter anodized aluminum
- Soft travel bag included
- All Made in the U.S.A.



Swage & Spring Button, Tool-Free Assembly



TOOL - FREE ASSEMBLY!

Center pole offers support.

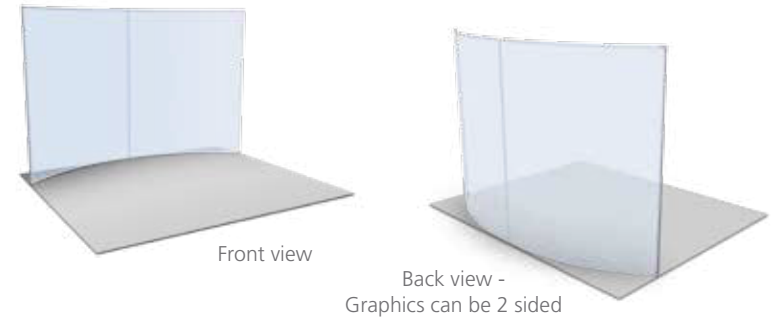

Front view

Back view -
Graphics can be 2 sided

Frame Structures

Frames	Width		Height	Depth
CC86	96"	120"	6'	30"
CC88	96"	Approximate	8'	30"
CC810	96"	Linear Length	10'	30"
CC106	117"	140"	6'	33"
CC108	117"	Approximate	8'	33"
CC1010	117"	Linear Length	10'	33"
CC126	144"	176"	6'	42"
CC128	144"	Approximate	8'	42"
CC1210	144"	Linear Length	10'	42"

As sewing techniques differ, please order the frame before graphic preparation.

Graphics available - call for pricing.



SNB1 (imported): Soft nylon bag keeps elements together, **FREE** with every Cool C Wall. 33" x 12" x 13".

Table Top Tension Fabric Displays

TOOL - FREE SET UP!
DESIGNED FOR PILLOWCASE GRAPHICS.

Straight Across



Curved, 17" Deep



UNITS SHOWN ON 6' TABLES, ALSO WELL SUITED FOR 8' TABLES.

Straight Models: 69" wide, includes 2 round 6-3/4" bases.

TBS3	36" high
TBS4	48" high
EBGH	Accessory Bag

- Affordable, portable
- Quick, tool-free assembly

- Designed for pillowcase graphics
- Lightweight, strong aluminum frames



Swage & Spring Button, Tool-Free Assembly

Curved Models: 69" wide, 17" deep, 80-5/8" Lineal Length.

TBC693	36" high
TBC694	48" high
EBGH	Accessory Bag

- Sturdy center pole ensures support
- Gently radiused corners

Halos™

HALO STRUCTURES

- 1-1/4" diameter aluminum tubing
- Easy swage & spring button assembly
- Satin anodized finish
- Metal eyebolts for hanging



Swage & Spring Button Construction

Shown below with graphics and harness sets - sold separately.
Custom sizes available.



HALO12 with HRNS5 harness

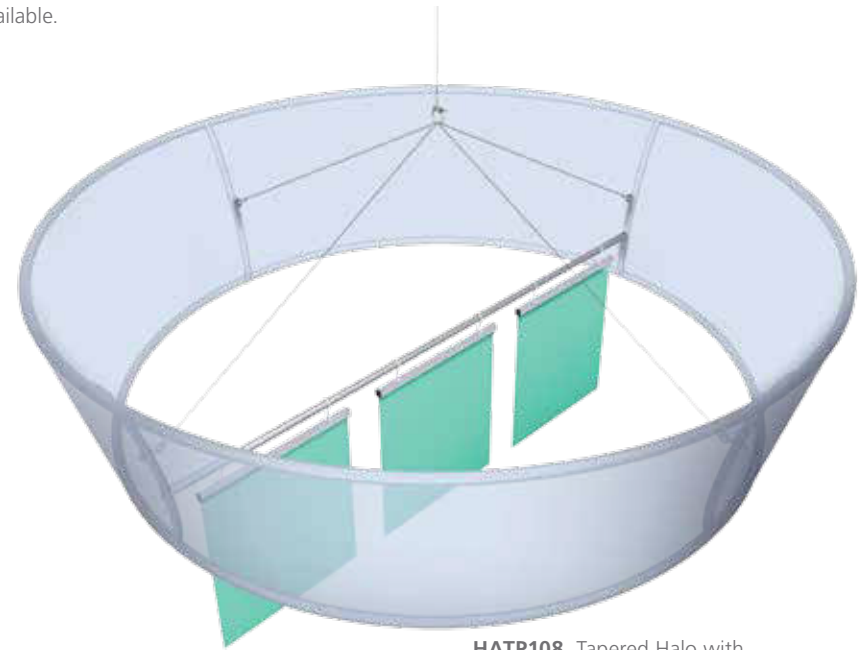

HATP108 Tapered Halo with HRNS4 Harness Set & custom Trapeze/Gripper Bar set.

Halos Equal in Diameter Top & Bottom

Model	Size	Height	Sections	Struts	Accessory Harness Set
HALO6	6' Diameter	2-1/2'	4	3	HRNS3
HALO8	8' Diameter	3-1/2'	5	4	HRNS4
HALO10	10' Diameter	3-1/2'	6	4	HRNS4
HALO12	12' Diameter	3-1/2'	7	5	HRNS5



Forged Eyebolts included with Halo Structures. Harness sets sold separately.

Tapered Halos Larger Diameter Tops, Smaller Bottoms

Model	Size	Height	Sections	Struts	Accessory Harness Set
HATP64	6' Top, 4' Bottom	2-1/2'	4	3	HRNS3
HATP86	8' Top, 6' Bottom	3-1/2'	5	4	HRNS4
HATP108	10' Top, 8' Bottom	3-1/2'	6	4	HRNS4
HATP1210	12' Top, 10' Bottom	3-1/2'	7	5	HRNS5

Disclaimer: Purchaser determines suitability of all product usage and assumes all risk & liability. Neither the seller nor manufacturer shall be held liable for any injury, loss or damage from use of product.

CIRCLE MOONS

- Strong aluminum alloy tubing
- Swage & spring button assembly
- Satin anodized finish
- Metal eyebolts for hanging

	Diameter	Gauge	# of Sections
MOON4	4'	1"	3
MOON5	5'	1"	3
MOON6	6'	1-1/4"	4

	Diameter	Gauge	# of Sections
MOON8	8'	1-1/4"	5
MOON10	10'	1-1/4"	6
MOON12	12'	1-1/4"	7

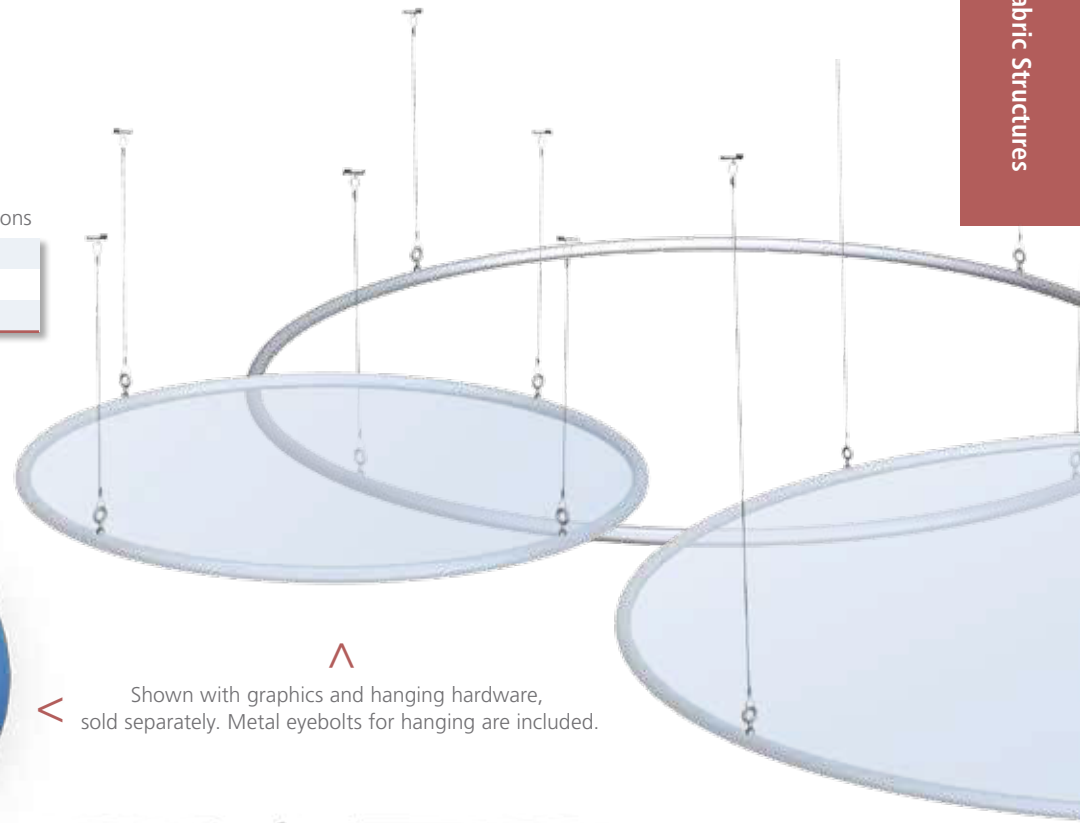

Shown with graphics and hanging hardware, sold separately. Metal eyebolts for hanging are included.



Swage & Spring Button Construction

FOR HALO STRUCTURES WE RECOMMEND HARNESS SETS

HRNS3 3 small shackles, 3 double loop lead wires (specify length), collection shackle, 20' pendant wire, 2 wire rope clips.

HRNS4 4 small shackles, 4 double loop lead wires (specify length), collection shackle, 20' pendant wire, 2 wire rope clips.

HRNS5 5 small shackles, 5 double loop lead wires (specify length), collection shackle, 20' pendant wire, 2 wire rope clips.



Forged wire rope clips for creating desired size top loops. Use 2 to insure safety.

Pendant Wire

Large forged collection shackle and smaller forged shackles that attach to eyebolts.

Lead Wires



FOR CIRCLE MOONS

Because these structures are lightweight, we recommend using Double C Hooks and anchors to attach to ceiling. Found on pages 90-91.

For added safety, Use harnesses.

Fully test every installation as conditions vary, and neither the manufacturer nor the sales representative may be held liable for injury or loss or damage resulting from the use of these products.

Halo Rails™

INNOVATIVE

BEAUTIFUL

ECONOMICAL



Fabric: Hemmed Graphics

Fabric graphics hang via pole pockets and plastic dowels top and bottom, which we supply.



HRPD - Extra plastic dowels 50' (for hemmed graphics)

Styrene Graphics

Styrene graphics hang from stapled soft plastic extrusions top and bottom.



HRSX - Extra plastic extrusions 50' (for styrene graphics)

Extra Graphic Holders

HALORAIL HALO KITS

Sold as a set
Top & bottom profiles, graphic holders, steel eyebolts.

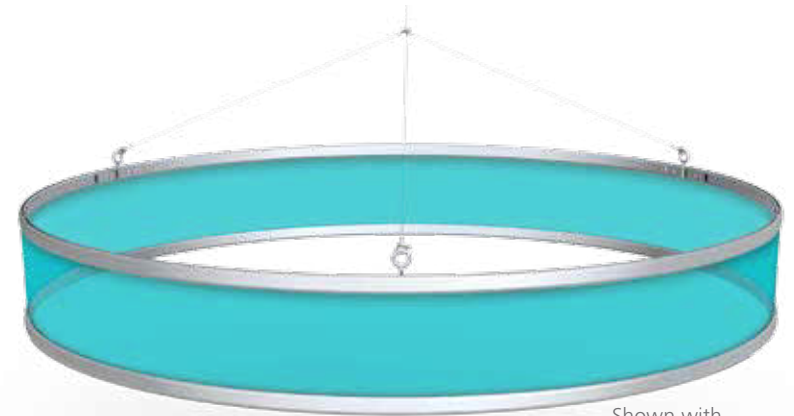

Shown with
Harness set, not included.

Features:

- Curved satin aluminum profiles handsomely house pole pocket graphics
- Strong, yet lightweight
- Height is equal to graphic height
- Ships ready for very easy assembly. Eyebolts come already attached.
- Quick graphic changeouts
- No costly vertical struts needed

HALORAIL HALO KITS

Diameter	Fabric, Hemmed Graphics	Styrene Graphics
6'	HRFK6	HRSK6
8'	HRFK8	HRSK8
10'	HRFK10	HRSK10
12'	HRFK12	HRSK12



Styrene graphics are stapled to plastic extrusions top and bottom. Swingline® Optima® 70 Desk Stapler, available at your local office supply supercenter.

HALORAIL FREEFORMS

Simple curves or elaborate FreeForms are all possible. Price is a function of quantity. Our engineering and sales team can work with your designers and price accordingly.



Minimum quantities & radius restrictions apply to above designs.

Horizon Pillowcase™

EASY TOOL - FREE ASSEMBLY



- Designed for pillowcase graphics
- Swage and spring button construction
- Eyebolts on top of units
- Satin anodized aluminum tubing

CUSTOM SIZES
AVAILABLE

Rectangles 1-1/4" tubing

Model	H x W x D (O.D.)
HPR3648	24" x 48" x 36"
HPR4248	24" x 48" x 42"
HPR3660	24" x 60" x 36"
HPR4260	24" x 60" x 42"

Cubes 1-1/4" tubing

Model	H x W x D (O.D.)
HPC18	18" x 18" x 18"
HPC24	24" x 24" x 24"
HPC30	30" x 30" x 30"
HPC36	36" x 36" x 36"

Triangles 1" tubing

Model	H x W (O.D.)
HPT36	18" x 36"
HPT42	24" x 42"
HPT48	24" x 48"
HPT60	30" x 60"

Swage & Spring Button Construction

Cross pieces can be any length, therefore custom sizes are available.



Hanging Eyebolts

Metal eyebolts are included at top of units.



Hanging Harness Sets Available



HORIZON PILLOWCASE TOWERS

- Designed for pillowcase graphics
- Easy tool-free assembly
- Swage and spring button construction
- Satin anodized aluminum tubing



TOOL-FREE
SWAGE & SPRING BUTTON CONSTRUCTION!



CUSTOM SIZES
AVAILABLE



Model	Shape	Size	Tube Diam.	Crossbar
HPWT2472	Tri	24" x 72"	1"	No
HPWT3072	Tri	30" x 72"	1"	No
HPWR2472	Square	24" x 72"	1-1/4"	Yes
HPWR3072	Square	30" x 72"	1-1/4"	Yes

Collage Pop-Ups™

EXTRAORDINARY 3D GRAPHIC EFFECTS



Complete Collage Kit **43K1**

A CLEVER NONTRADITIONAL POP-UP

- Create 3D effects
- Incredibly eye-catching
- Lightweight aluminum
- Infinite configurations
- Instant set-up - take down
- Padded Roller Bag included

Pick - a - Kit Ordering Made Simple!

90 Standard Kits to choose from, design and upload your graphics, and get ready to be amazed.

Consult your printer for exact graphic specifications.



Complete catalog with 100 designs at:
www.displayfolio.com/pdf/collage

Complete Kits include:
 Custom printed graphics,
 Frame & Padded Roller Bag.



INSTANT SET UP AND KNOCK DOWN

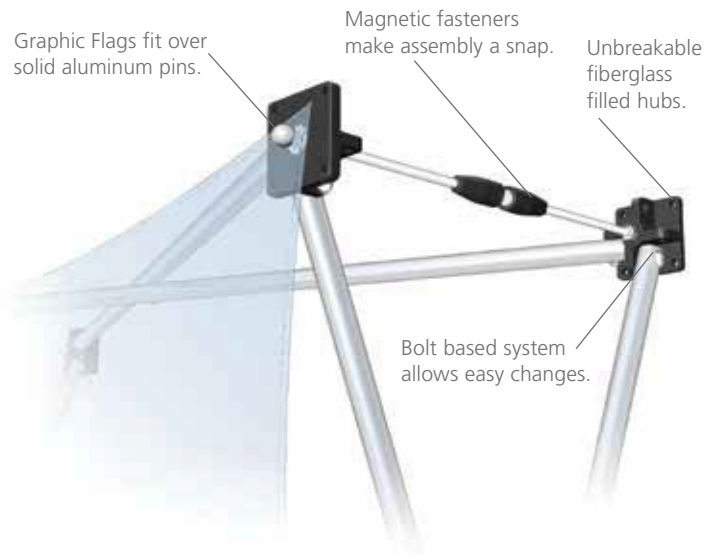

ENDLESS CREATIVE POSSIBILITIES



Complete Collage Kit 33K16

EIGHT STANDARD FRAME STRUCTURES

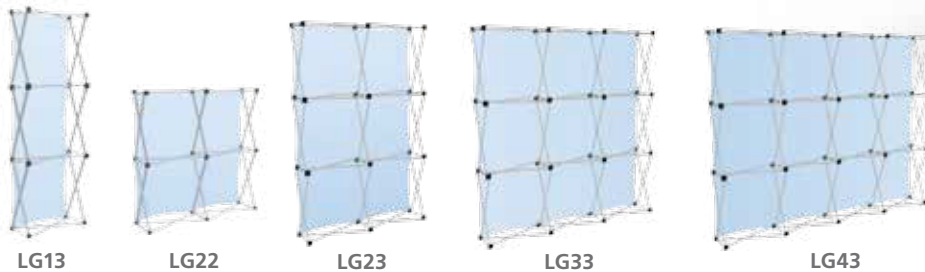
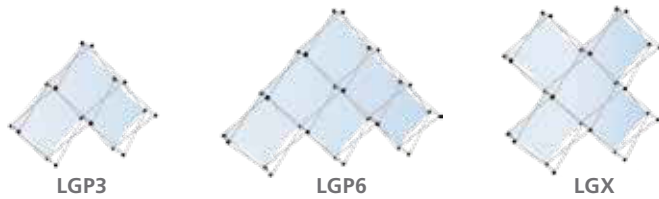

Collage Pop-Ups™

PICK - A - KIT ORDERING MADE SIMPLE!



43K Custom Kit
 LG43 Frame
 2: CK Shelves
 6: CF1A
 1: CFF43

Choose from 90 standard layouts - or create your own.

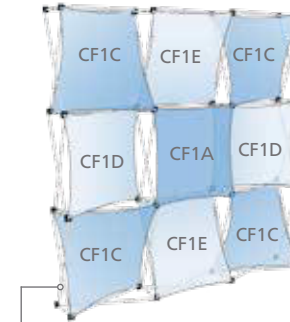

33K4 Kit
 LG33 Frame
 1: CF1A
 4: CF1C
 2: CF1D
 2: CF1E

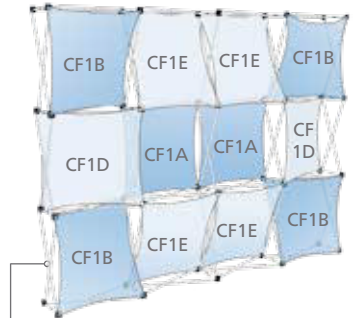

43K2 Kit
 LG43 Frame
 2: CF1A
 4: CF1B
 2: CF1D
 4: CF1E



90 Standard Kits to choose from, design and upload your graphics, and get ready to be amazed.

Complete catalog available at:
www.displayfolio.com/pdf/collage

Consult your printer for exact graphic specifications.

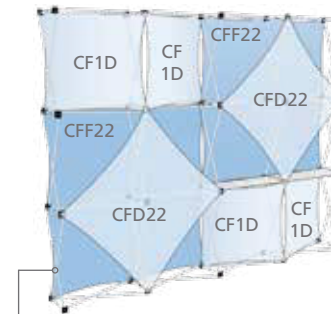

43K5 Kit
 LG43 Frame
 2: CK Shelves
 2: CFF22
 2: CFD22
 4: CF1D

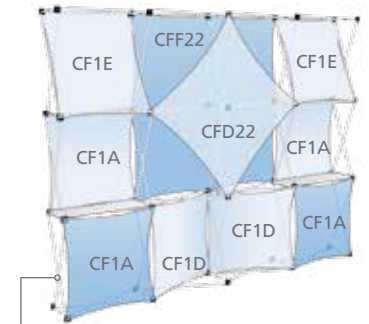

43K10 Kit
 LG43 Frame
 2: CK Shelves
 1: CFF22
 1: CFD22
 4: CF1A
 2: CF1D
 2: CF1E

GRAPHICS

High impact 720 dpi Dye Sub Printing on a virtually "wrinkle free" stretch fabric, designed and engineered for this application.

EXTRAORDINARY 3D GRAPHIC EFFECTS!



13K1 Kit



13K12 Kit



23K1 Kit



P3K1 Kit



XK1 Kit



P6K10 Kit



Presto Pop-Ups™

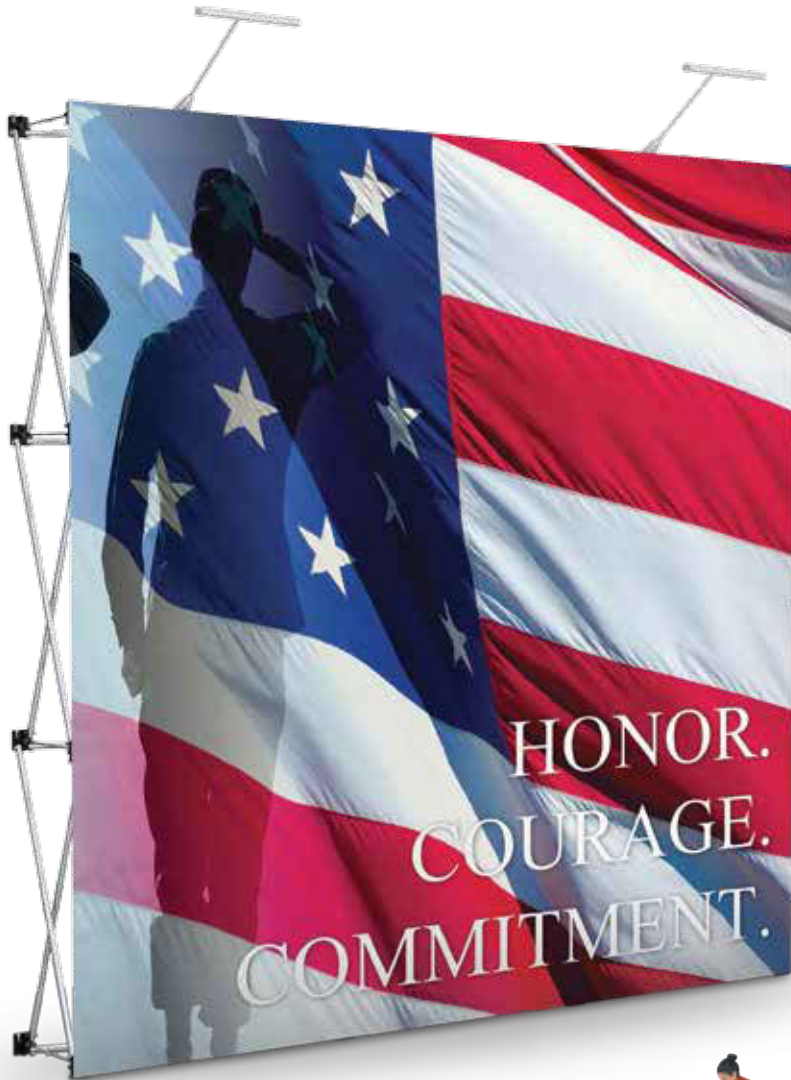

PFK33 with GF33A graphic and (2) LEDPU lights.



Travel Bag included with every unit.

A VIRTUAL PORTABLE BILLBOARD

Frame Features:

- Graphic stays attached to frame in bag
- Hook perimeters included
- Incredibly easy, two minute set-up without tools
- Free oversized nylon carry bag with every frame
- Upgraded Portable Exhibit Cases available
- Ultra lightweight alloy tubes
- Matte satin anodized finish
- Adjustable leveling feet
- Bolt based system, add or subtract components

Available Configurations:

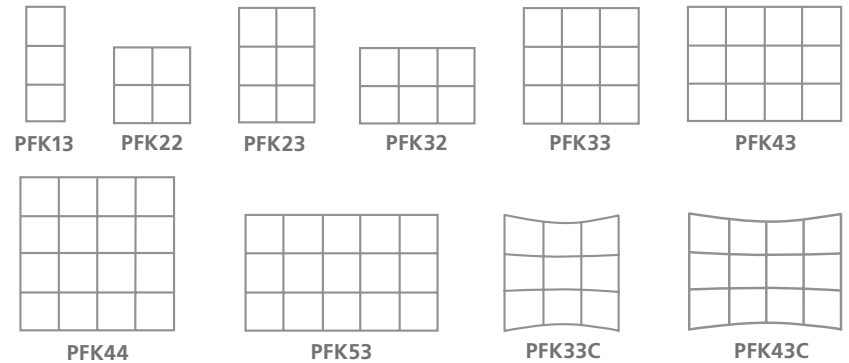

Frames

Model #	W x H	Wt. (lbs.)
PFK13	1 x 3 Quads	16
PFK22	2 x 2 Quads	17
PFK23	2 x 3 Quads	20
PFK32	3 x 2 Quads	20
PFK33	3 x 3 Quads	23
PFK43	4 x 3 Quads	31
PFK44	4 x 4 Quads	36
PFK53	5 x 3 Quads	36
	Curved	
PFK33C	3 x 3 Quads	25
PFK43C	4 x 3 Quads	31

Note: Each quad is approximately 30" x 30".

THE ULTIMATE IN PRESENTATION CONVENIENCE!

Our American made frame is the unsurpassed standard in Quality and Value.

These units "Pop-UP" and assemble in minutes. Graphics can stay attached to frame when closed.

Presto Pop-Up displays are ultra easy to set-up and the amazing quality dye sub graphic ensures maximum impact.

AMERICAN MADE VALUE AND RELIABILITY

Dye Sub Fabric Graphics

Regular		with End Panels	
GF13A	31" x 88.25"	GF13B	56" x 88.25"
GF22A	59.5" x 59.5"	GF22B	84.5" x 59.5"
GF23A	59.5" x 88.25"	GF23B	84.25" x 88.25"
GF32A	88.25" x 59.5"	GF32B	113.25" x 59.5"
GF33A	88.25" x 88.25"	GF33B	113.25" x 88.25"
GF43A	117.375" x 88.25"	GF43B	142.375" x 88.25"
GF44A	117" x 117"	GF44B	142" x 117"
GF53A	145.75" x 88.25"	GF53B	170.75" x 88.25"
Curved			
GF33AC	80" x 88.25"	GF33BC	105" x 88.25"
GF43AC	106" x 88.25"	GF43BC	131" x 88.25"

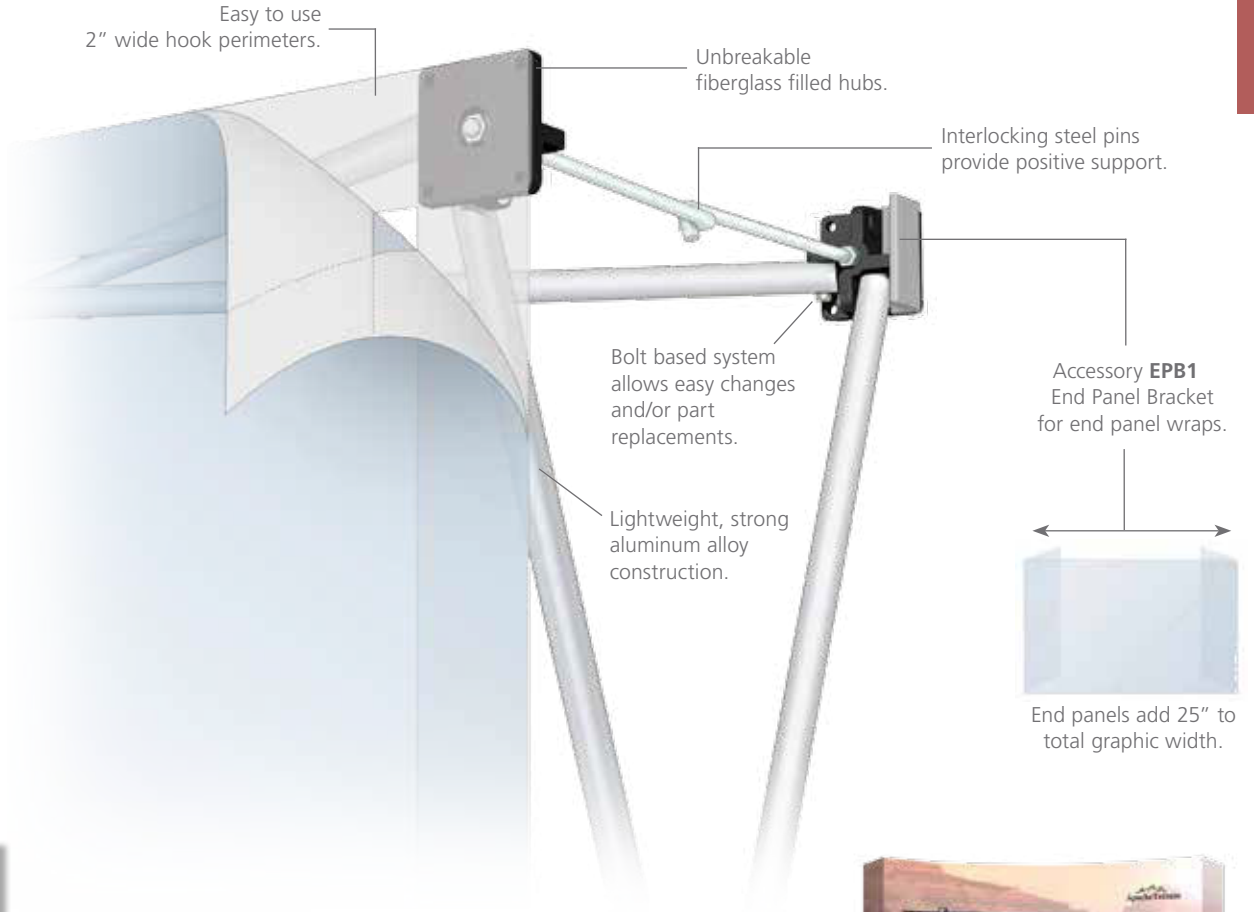

Fabric Graphics

High impact 720 DPI Dye Sub Printing on a virtually "wrinkle free" stretch fabric, designed and engineered for this application. Custom printed from your art work.



Curved Presto Frame **PFK43C**, **GF43BC** graphic with end panels.

Presto Pop-Ups™

End Panel Brackets facilitate the wrapping of the sides, adding 25" to total graphic width.
A bracket is needed for each outer hub and assembly is easy.

Both straight and curved units can have their sides wrapped.

To completely enclose the frame - front, back and sides,
End Panel Brackets are required, plus an extra Velcro® brand hook perimeter.



EPB1 Brackets easily attach to frame with screws.



JB1 Joining Brackets join frames together, call to determine quantity.



Curved unit with end panels:

PFK43C curved frame, **EPB1** end panel brackets (8), **GF43BC** graphic face



Completely enclosed on 4 sides:

PFK32 straight frame, **EPB1** end panel brackets, **32VB** extra hook perimeter, **GF32A** and a **GF32B** graphic.

Superwide Presto Pop-Ups™



We will custom produce Pop-Up Frames to any quad configuration, no matter how many quads.

The Velcro® brand perimeters, are sewn in our own factory to exacting specifications.

Quads are always 30" square. Large frame assemblies more than 15 quads do not include carry bags.

For pricing contact our friendly sales department.

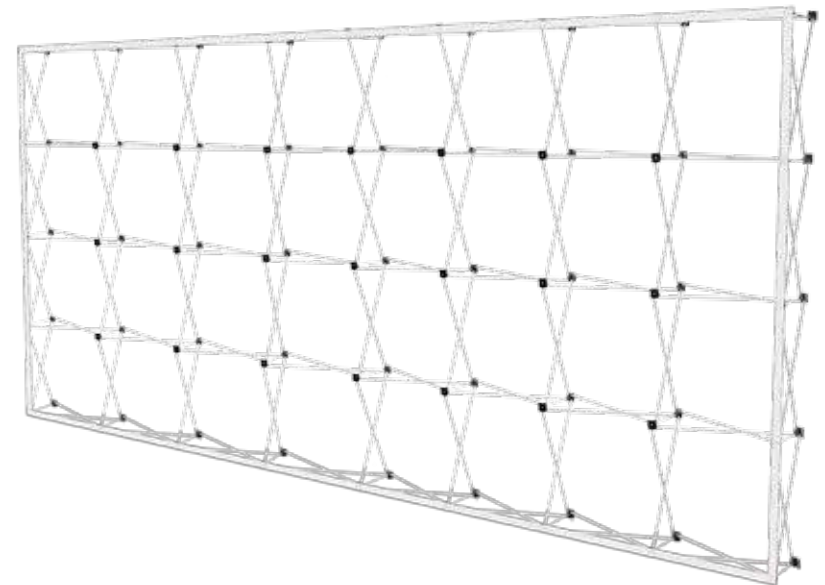

Presto Pop-Up™ Light Kits

LIGHT KITS TO MAKE YOUR POP-UP SHINE!

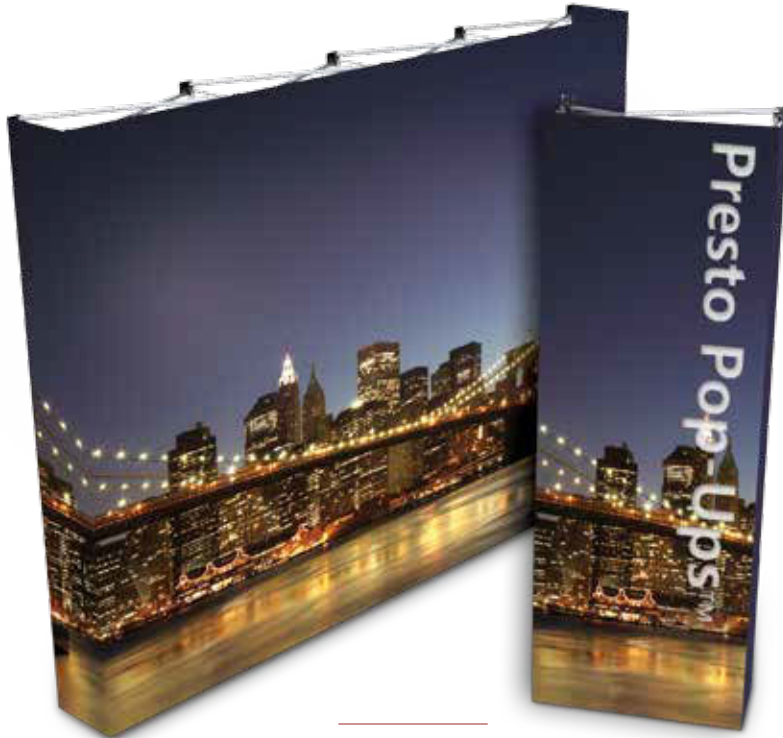

SOLD AS COMPLETE KITS

Each kit includes:

- A lamp & fixture for each quad
- Power supply cords & power strip
- Carry bag to keep kit contained.

Pop-Up Light Kits

Model	Quads w x h	Model	Quads w x h
PFKLK13	1 x 3	PFKLK43	4 x 3
PFKLK22	2 x 2	PFKLK44	4 x 4
PFKLK23	2 x 3	PFKLK53	5 x 3
PFKLK32	3 x 2	PFKLK33C	3 x 3 Curved
PFKLK33	3 x 3	PFKLK43C	4 x 3 Curved

Disclaimer: Though we use clear hubs, sometimes they create visible shadows - depends on graphic pattern.

Features:

- Sold as a complete kit
- Quick easy assembly
- Long lasting TS lamps
- Connecting cords & power strip
- Aluminum brackets snap to frames
- Good for 1 sided or 2 sided Pop-Ups
- Energy efficient, easy to replace lamps
- Carry bag keeps parts contained



Cool white fluorescent lamps connect in series, one for each quad. Aluminum mounting brackets make set up very easy.

Presto Pop-Up™ Accessories

Extra Bags (imported):

SNB1 33" x 12" x 13"
up to 3 x 3 frame

LNB1 33" x 18" x 13"
up to 5 x 3 frame



Podium Cases: (imported):

Hard plastic designed for Pop-Ups. Doubles as a Podium; add a Graphic Wrap to deliver your message.



OPC1

OPC1 & GFW1

OPC2 (2 shown)

Hook Perimeters:

Use with end panel brackets for enclosing frame on all sides.

13VB	23VB	33VB	44VB
22VB	32VB	43VB	53VB

OPC1	24" w x 15-1/2" d x 38" h (O.D.) Podium Case. Simulated wood top
GFW1	Graphic for OPC1. Size: 70-1/2" w (includes 2" overlap) x 31" h

OPC2	16-1/4" w x 14-1/2" d x 34-3/4" h (O.D.) Half Podium Case
GFW2	Graphic for OPC2. Size: 50-1/2" w (includes 2" overlap) x 27-1/2" h

Weighted Base

PFKWB Laser cut marquise shaped steel bases. Must be ordered with frames, as we pre-punch matching holes.



Pop-Up Lights (imported)

PULD1 Very bright LED trade show light for Pop-Ups, 18w.



LEDPU for Pop-Ups.



Use for: Presto Pop-Ups, Collage Pop-Ups, & most other manufacturers pop-ups.



nema

MARKETING & DESIGN AGENCY

NEMA ASSOCIATES INC.

THE **DISPLAY FOLIO**
Exhibit & Display Catalog

(908) 275-3840

408 E ELIZABETH AVE. LINDEN, NJ 07036

Visit www.nemadesign.com to view or download a digital copy of this catalog.